

CAE 465/526 Building Energy Conservation Technologies

Fall 2022

September 21, 2022
OpenStudio and Advanced HVAC Systems

Built
Environment
Research

@ IIT



*Advancing energy, environmental, and
sustainability research within the built environment*

www.built-envi.com

Dr. Mohammad Heidarinejad, Ph.D., P.E.
Civil, Architectural and Environmental Engineering
Illinois Institute of Technology

muh182@iit.edu

ANNOUNCEMENTS

Announcements



Mechanical Design Advise & Professional Networking

SPEAKER

Mechanical Designer **Aaron Horta**

WHEN

September 22nd, 2022
12:40pm – 1:40pm

WHERE

John T. Rettaliata
Engineering Center,
RE 124

TALK ABOUT

- ✓ Work Experiences
- ✓ Mechanical Design
- ✓ Tips & IIT Courses

For more information,
feel free to contact
ASHRAE official email
ashrae_iit@iit.edu



Interested in Joining

Lunch will be provided!

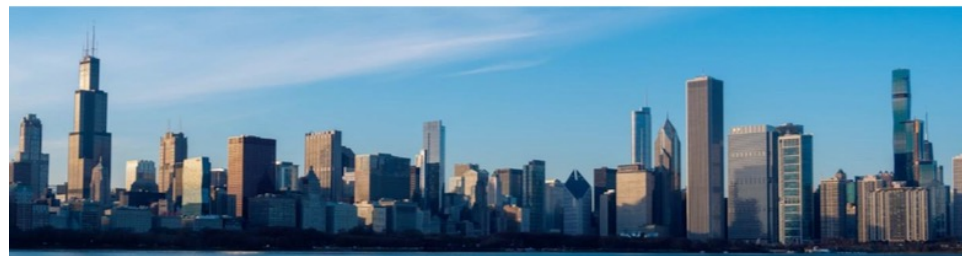

Announcements

- Assignment 3 is due tonight

ASSIGNMENT FEEDBACK

Assignment Feedback

- Use the right construction set (e.g., “189.1-2009-cz5-office” is not the right construction set for our climate)

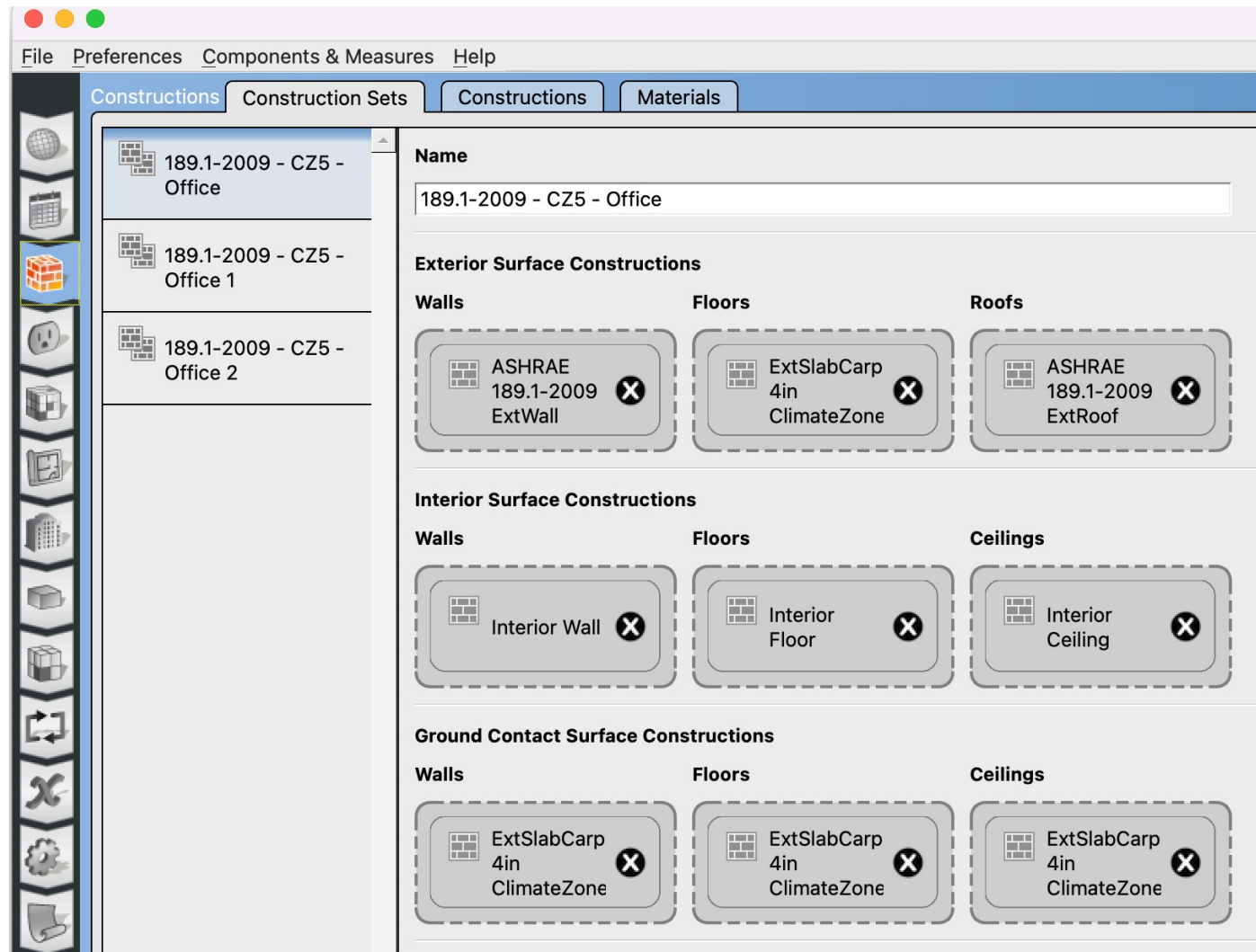

Assignment Feedback

- Simplifications should be reasonable (not too simplified):

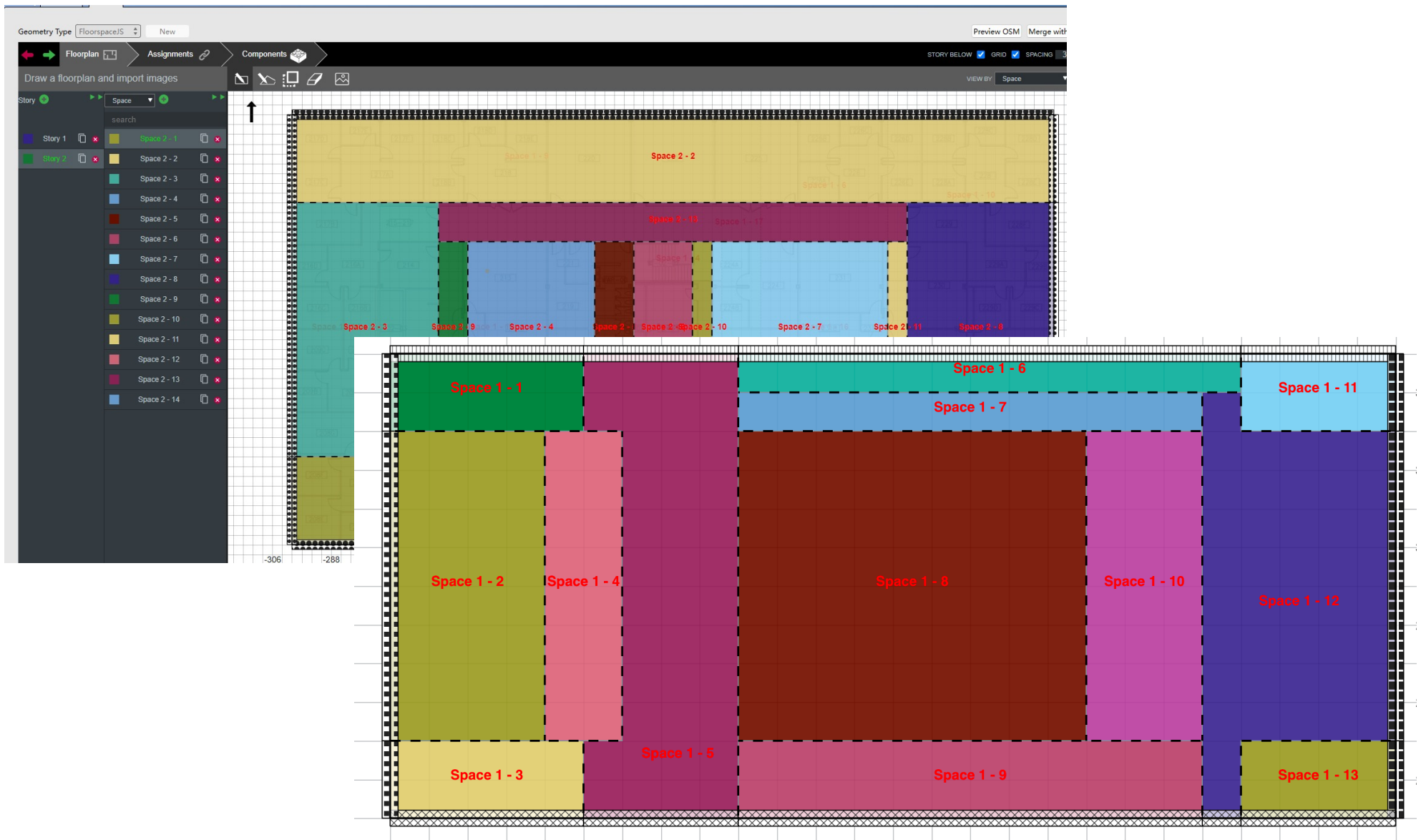

Assignment Feedback

- Simplifications should be reasonable:

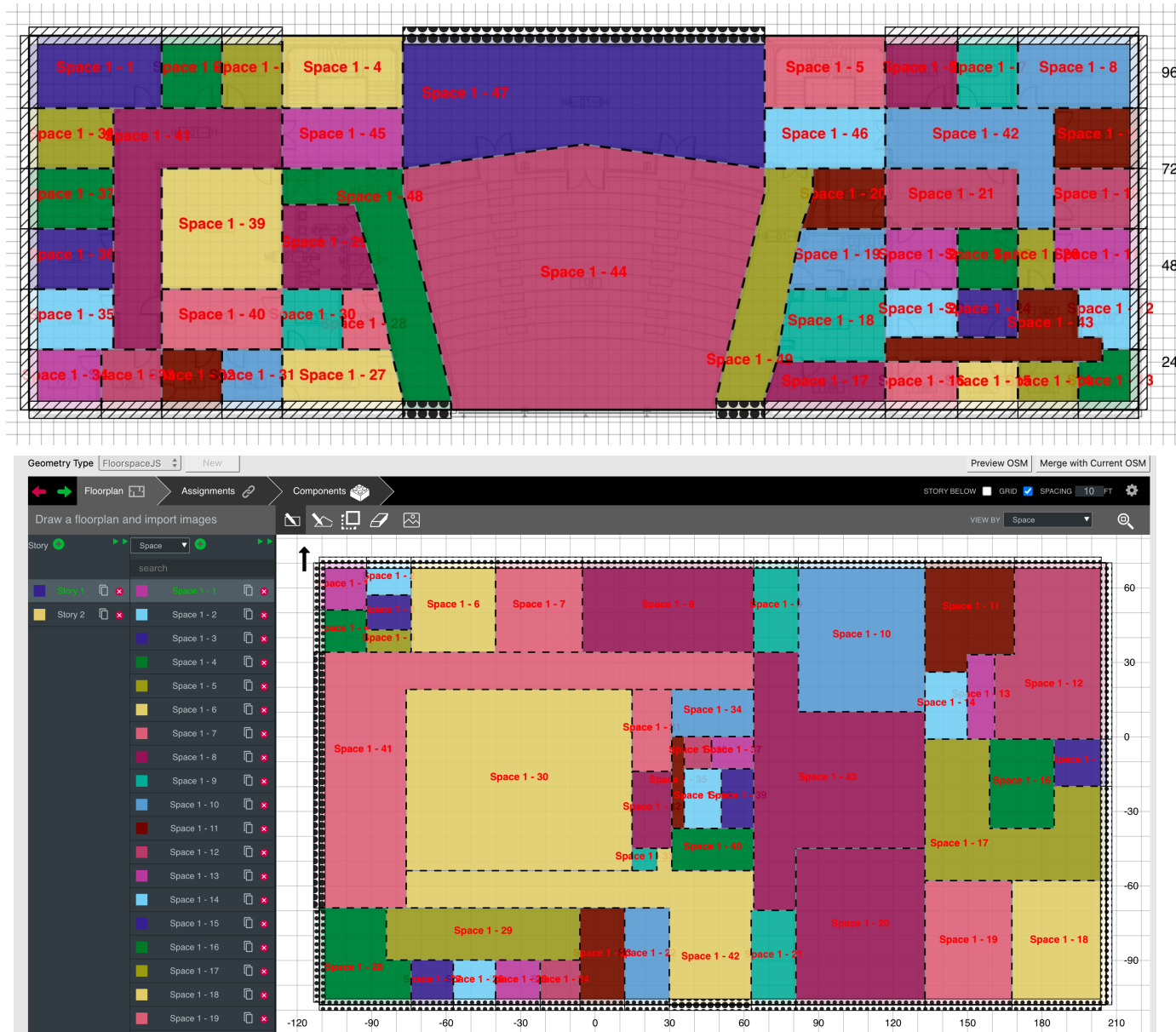

Assignment Feedback

- Simplifications should be reasonable:

How did you create?

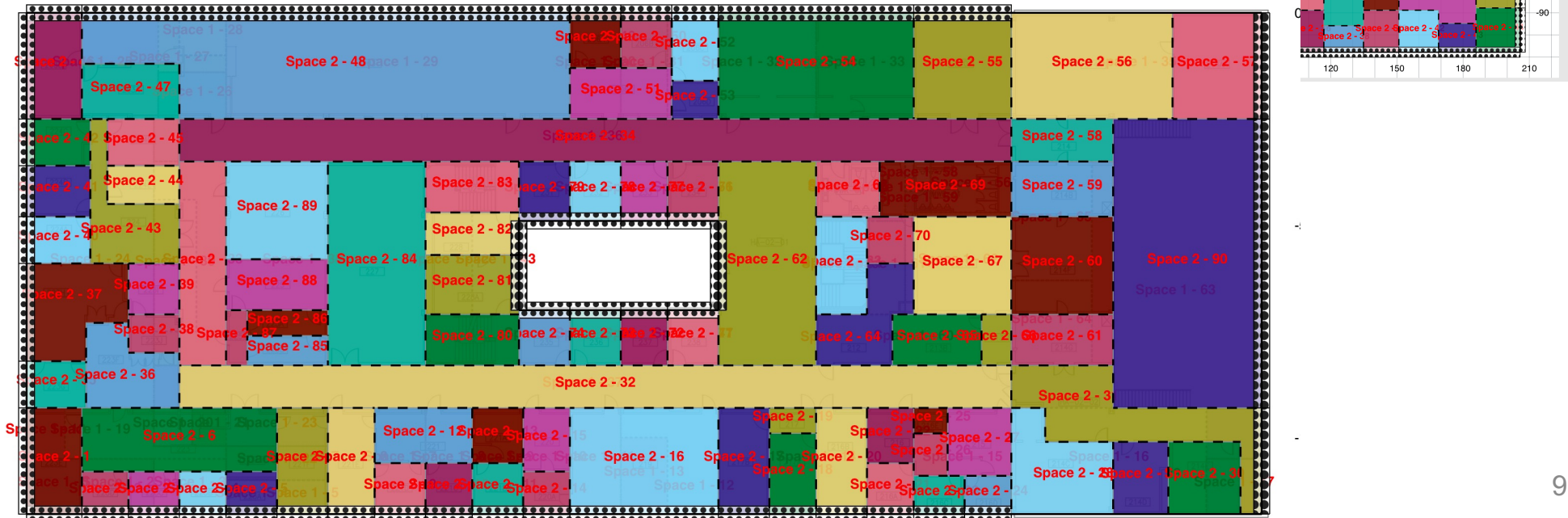

Assignment Feedback

- Be careful of the space types and schedule rulesets:

HW 2 Minyoung Kim.osm

File Preferences Components & Measures Help

Space Types

Drop Space Type

General Loads Measure Tags Custom

Filter: Load Type
Show all loads

Space Type Name	All	Rendering Color	Default Construction Set	Default Schedule Set	Design Specification Outdoor Air	Space Infiltration Design Flow Rates	Space Infiltration Effective Leakage Areas
	<input type="checkbox"/>		Apply to Selected	Apply to Selected	Apply to Selected	Apply to Selected	Apply to Selected
Office - ClosedOffice - CZ4-8	<input type="checkbox"/>		DOE Ref Pre-1980 - Off	189.1-2009 - Office - C	189.1-2009 - Office - C	Office - CZ4-8 Infiltration	
Office - Corridor - CZ4-8	<input type="checkbox"/>		DOE Ref Pre-1980 - Off	189.1-2009 - Office - C	189.1-2009 - Office - C	Corridor - CZ4-8 Infiltration	
Office - IT_Room - CZ4-8	<input type="checkbox"/>		DOE Ref Pre-1980 - Off	189.1-2009 - Office - IT	189.1-2009 - Office - IT	Room - CZ4-8 Infiltration	
Office - Lobby - CZ4-8	<input type="checkbox"/>		DOE Ref Pre-1980 - Off	189.1-2009 - Office - L	189.1-2009 - Office - L	Lobby - CZ4-8 Infiltration	
Office - Restroom - CZ4-8	<input type="checkbox"/>		DOE Ref Pre-1980 - Off	189.1-2009 - Office - R	189.1-2009 - Office - R	Restroom - CZ4-8 Infiltration	
Office - Stair - CZ4-8	<input type="checkbox"/>		DOE Ref Pre-1980 - Off	189.1-2009 - Office - S	189.1-2009 - Office - S	Stair - CZ4-8 Infiltration	

BUILDING MECHANICAL SYSTEMS

Building Mechanical Systems

- Purpose of building mechanical systems is to control indoor air parameters within required:
 - Thermal comfort
 - Indoor air quality

- To achieve required indoor air parameters, the system needs to conduct the following heat transfer processes:
 - Heat
 - Cool
 - Humidify
 - Dehumidify
 - Filter outdoor air

Building Mechanical Systems

- HVAC system consists of four main parts:
 - ❑ Primary systems or central plant
 - ❑ Distribution system
 - ❑ Terminal devices
 - ❑ Controls

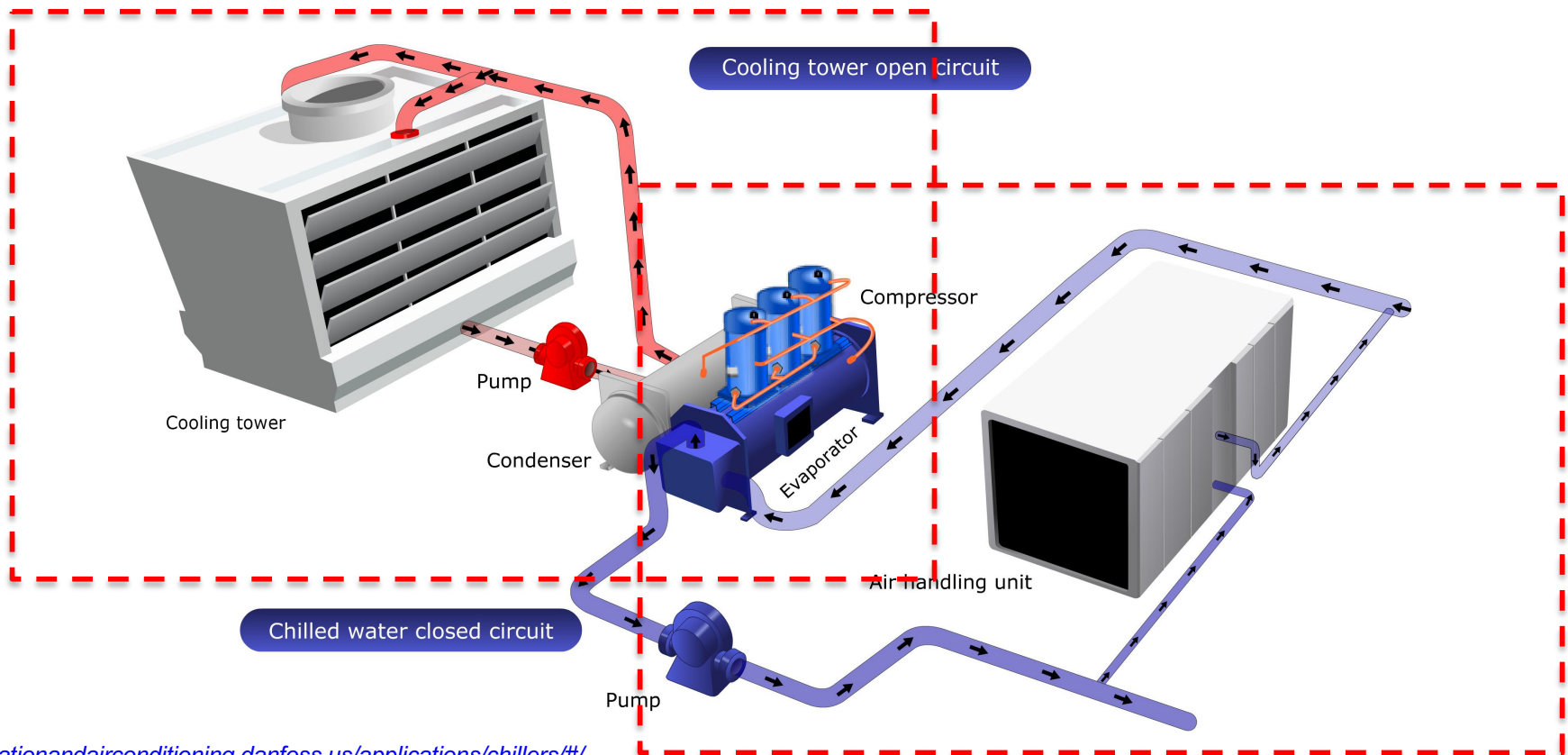

Building Mechanical Systems

- Air distribution systems include air handlers, ductwork, and associated components for heating, ventilating, and air-conditioning buildings

□ Air distribution components:

- Air distribution devices
- Ductwork
- Dampers
- Fans
- Controls

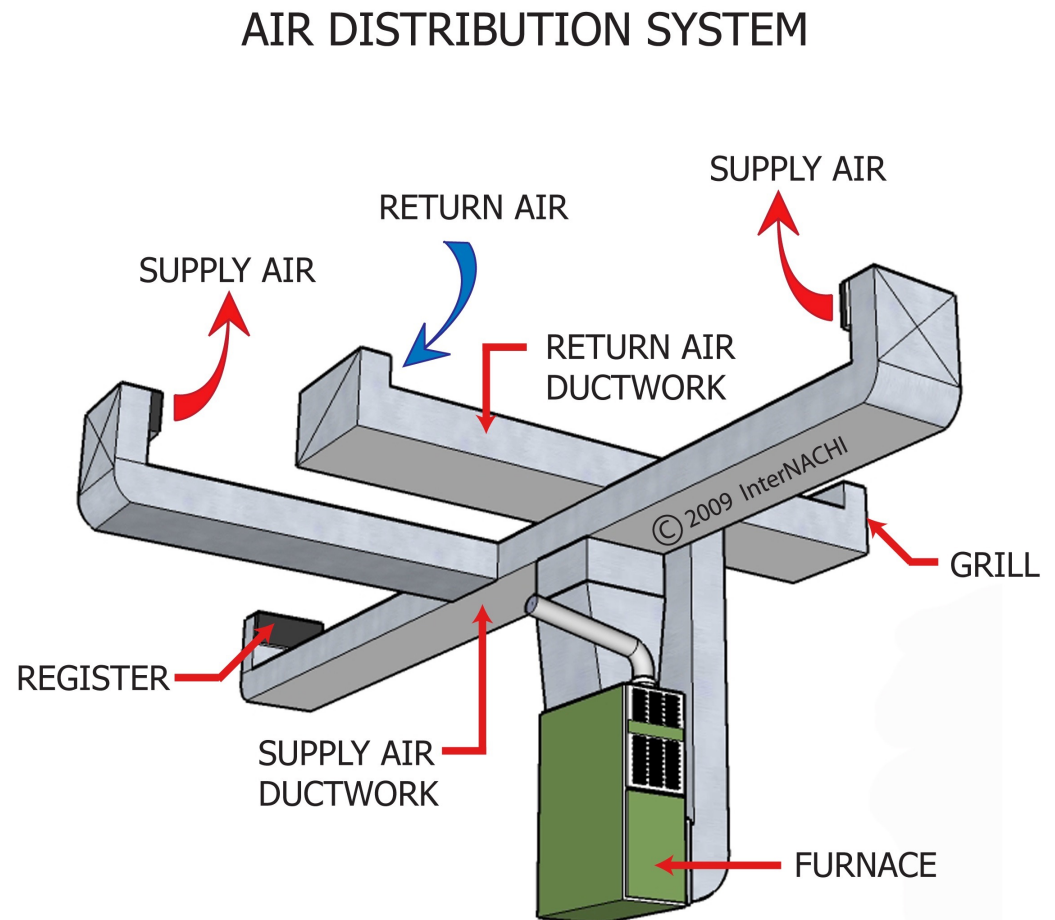

Building Mechanical Systems

- Do we use this system at IIT?

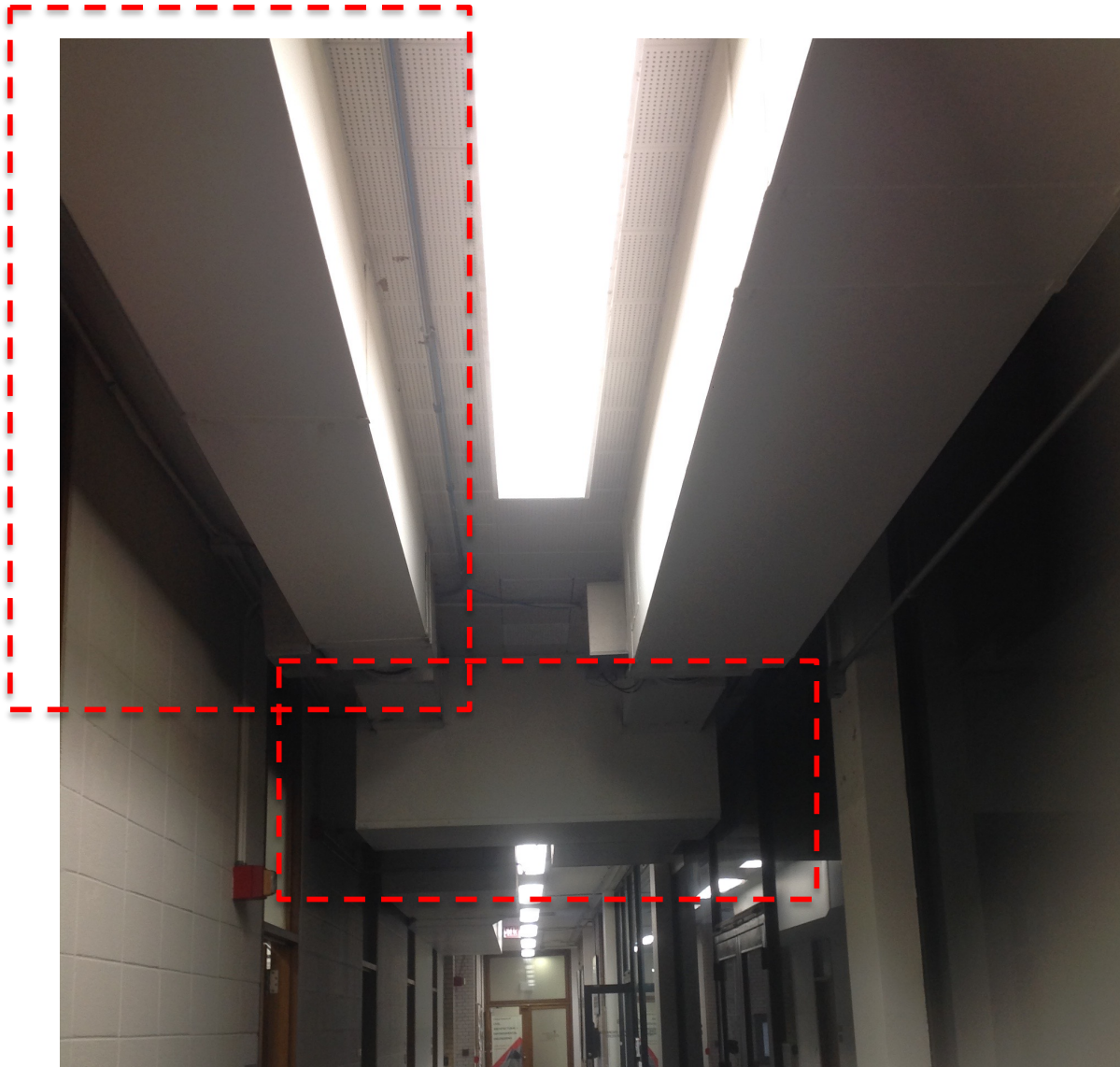

Building Mechanical Systems

- Hydronics refers to systems focused on heating or cooling with water:

- Steam or chiller water systems

- Boiler or chiller
- Piping
- Valves
- Pumps
- Controls

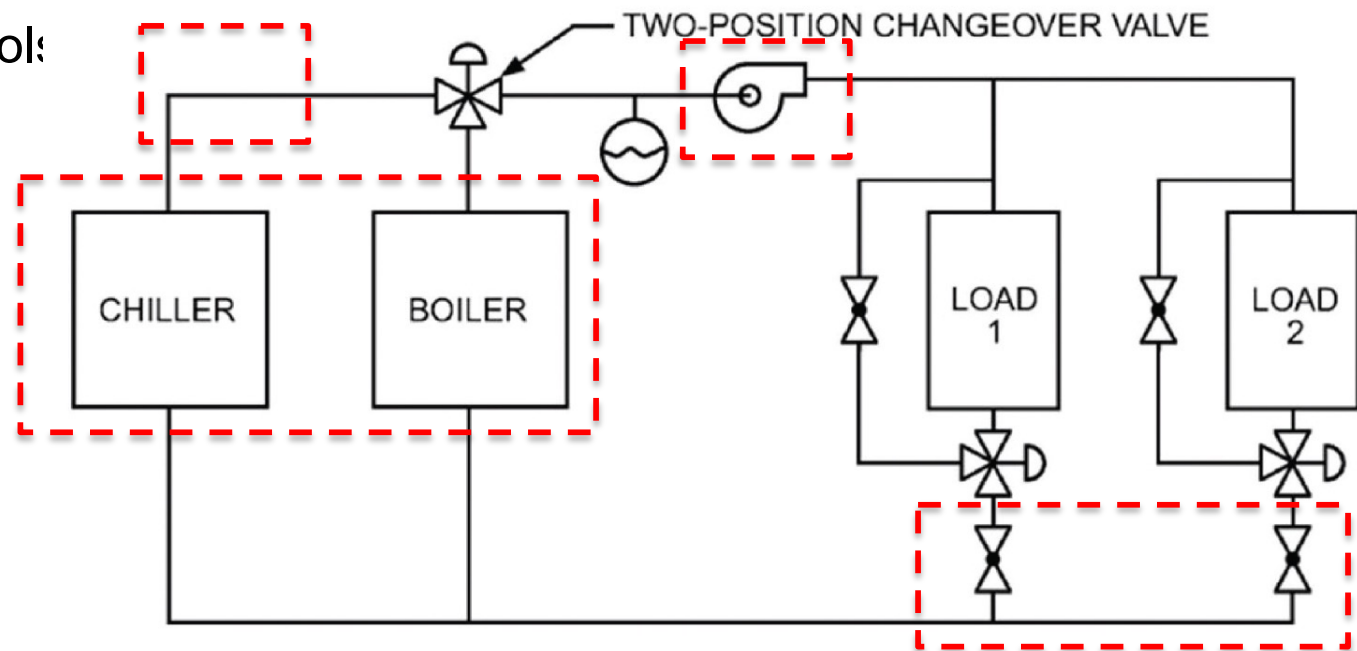

Building Mechanical Systems

- Refrigeration refers to the process of removing heat from a low-temperature reservoir and transferring it to a high-temperature reservoir.

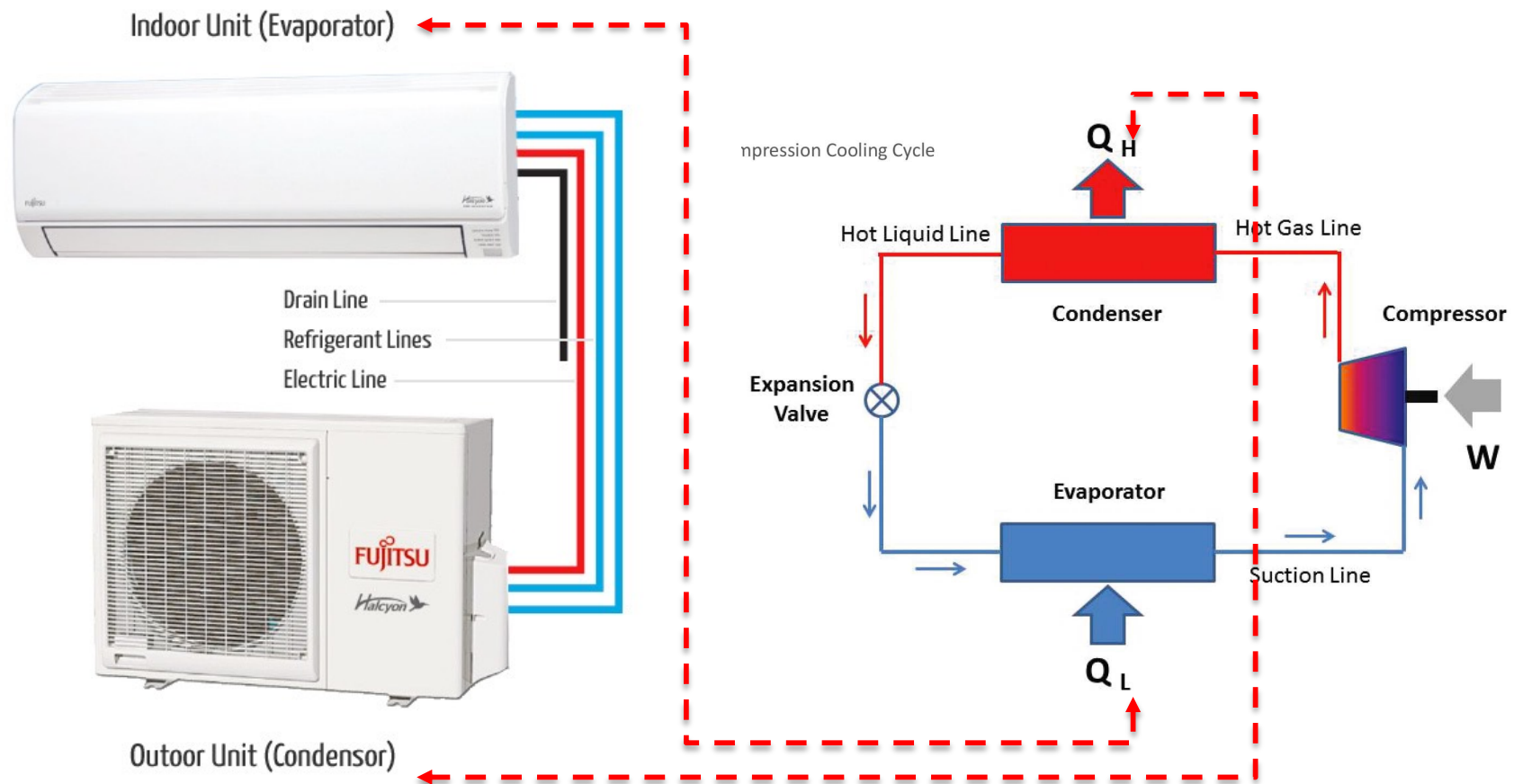

Building Mechanical Systems

- HVAC systems categories in terms of their distribution are:
 - Unitary
 - Local systems
 - Each room has an HVAC system
 - Centralized
 - Central systems (all HVAC equipment in one room)
 - Semi-central systems
 - District
 - Central systems (all HVAC equipment in one room)
 - Semi-central systems

Building Mechanical Systems

- Few examples of the graphical symbols:

Refrigeration

Compressors

Centrifugal

Reciprocating

Rotary

Rotary screw

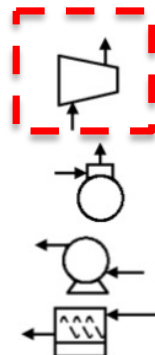

Condensers

Air cooled

Evaporative

Water cooled, (specify type)

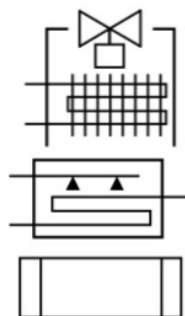

Condensing Units

Air cooled^b

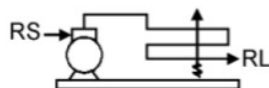

Air Moving Devices and Components

Fans (indicate use)^a

Axial flow

Centrifugal

Propeller

Roof ventilator, intake

Roof ventilator, exhaust

Roof ventilator, louvered

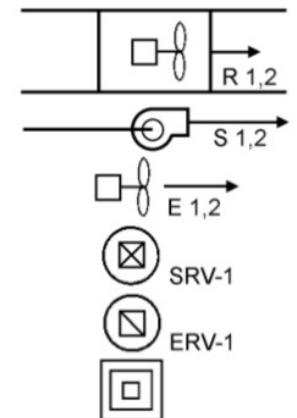

Ductwork^b

Direction of flow

Duct size, first figure is side down

Duct section, positive pressure, first figure is top

Duct section, negative pressure

Change of elevation
rise (R) drop (D)

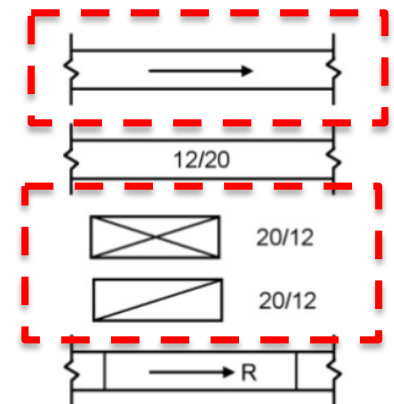

Building Mechanical Systems

- Heating production:
 - ❑ Equipment: Boiler, furnace, heat pump
 - ❑ Energy: combustion, electrical, waste heat
 - ❑ Distribution: air, steam, water

- Cooling production:
 - ❑ Equipment: Air conditioner, chiller, heat pump
 - ❑ Energy: electrical, natural gas, steam, waste heat
 - ❑ Cycle: vapor compression, absorption
 - ❑ Distribution: chilled water, air

Building Mechanical Systems

- Three main ventilation strategies are:
 - ❑ Constant Air Volume (CAV):
 - Hold the system airflow rate constant
 - Let the space thermostat modulate the supply air temperature
 - ❑ Variable Air Volume (VAV):
 - Modulate supply airflow rate
 - Hold the supply air inlet temperature constant
 - ❑ Dedicated Outdoor Air System (DOAS):
 - Consist of two parallel systems
 - Deliver outdoor to handle both latent and sensible loads
 - Include a parallel system to handle mostly sensible loads

ASHRAE 90.1 APPENDIX G

ASHRAE Appendix G 90.1

- From ASHRAE Appendix G 2019:

Table G3.1.1-4 Baseline System Descriptions

<i>System No.</i>	<i>System Type</i>	<i>Fan Control</i>	<i>Cooling Type^a</i>	<i>Heating Type^a</i>
1. <i>PTAC</i>	<i>Packaged terminal air conditioner</i>	Constant volume	Direct expansion	Hot-water <i>fossil fuel boiler</i>
2. <i>PTHP</i>	<i>Packaged terminal heat pump</i>	Constant volume	Direct expansion	Electric heat pump
3. <i>PSZ-AC</i>	Packaged rooftop air conditioner	Constant volume	Direct expansion	<i>Fossil fuel furnace</i>
4. <i>PSZ-HP</i>	Packaged rooftop heat pump	Constant volume	Direct expansion	Electric heat pump
5. <i>Packaged VAV with reheat</i>	<i>Packaged rooftop VAV with reheat</i>	<i>VAV</i>	Direct expansion	Hot-water <i>fossil fuel boiler</i>
6. <i>Packaged VAV with PFP boxes</i>	<i>Packaged rooftop VAV with parallel fan power boxes and reheat</i>	<i>VAV</i>	Direct expansion	<i>Electric resistance</i>
7. <i>VAV with reheat</i>	<i>VAV with reheat</i>	<i>VAV</i>	Chilled water	Hot-water <i>fossil fuel boiler</i>
8. <i>VAV with PFP boxes</i>	<i>VAV with parallel fan-powered boxes and reheat</i>	<i>VAV</i>	Chilled water	<i>Electric resistance</i>
9. <i>Heating and ventilation</i>	Warm air furnace, gas fired	Constant volume	None	<i>Fossil fuel furnace</i>
10. <i>Heating and ventilation</i>	Warm air furnace, electric	Constant volume	None	<i>Electric resistance</i>
11. <i>SZ-VAV</i>	Single-zone <i>VAV</i>	<i>VAV</i>	Chilled water	See note (b).
12. <i>SZ-CV-HW</i>	<i>Single-zone system</i>	Constant volume	Chilled water	Hot-water <i>fossil fuel boiler</i>
13. <i>SZ-CV-ER</i>	<i>Single-zone system</i>	Constant volume	Chilled water	<i>Electric resistance</i>

a. For purchased chilled water and purchased heat, see G3.1.1.3.

b. For Climate Zones 0 through 3A, the heating type shall be *electric resistance*. For all other climate zones the heating type shall be hot-water fossil-fuel boiler.

ASHRAE Appendix G 90.1

- From ASHRAE Appendix G 2019:

Table G3.1.1-3 Baseline HVAC System Types

<i>Building Type, Number of Floors, and Gross Conditioned Floor Area</i>	<i>Climate Zones 3B, 3C, and 4 to 8</i>	<i>Climate Zones 0 to 3A</i>
<i>Residential</i>	<i>System 1—PTAC</i>	<i>System 2—PTHP</i>
Public assembly <120,000 ft ²	<i>System 3—PSZ-AC</i>	<i>System 4—PSZ-HP</i>
Public assembly ≥120,000 ft ²	<i>System 12—SZ-CV-HW</i>	<i>System 13—SZ-CV-ER</i>
Heated-only storage	<i>System 9—Heating and ventilation</i>	<i>System 10—Heating and ventilation</i>
Retail and 2 floors or fewer	<i>System 3—PSZ-AC</i>	<i>System 4—PSZ-HP</i>
Other nonresidential and 3 floors or fewer and <25,000 ft ²	<i>System 3—PSZ-AC</i>	<i>System 4—PSZ-HP</i>
Other nonresidential and 4 or 5 floors and <25,000 ft ² or 5 floors or fewer and 25,000 ft ² to 150,000 ft ²	<i>System 5—Packaged VAV with reheat</i>	<i>System 6—Packaged VAV with PFP boxes</i>
Other nonresidential and more than 5 floors or >150,000 ft ²	<i>System 7—VAV with reheat</i>	<i>System 8—VAV with PFP boxes</i>

Notes:

- Residential building* types include dormitory, hotel, motel, and multifamily. *Residential space* types include guest rooms, living quarters, private living space, and sleeping quarters. Other *building* and *space* types are considered *nonresidential*.
- Where attributes make a *building* eligible for more than one baseline *system* type, use the predominant condition to determine the *system* type for the entire *building* except as noted in Section G3.1.1.
- For laboratory *spaces* in a *building* having a total laboratory exhaust rate greater than 15,000 cfm, use a single *system* of type 5 or 7 serving only those *spaces*.
- For hospitals, depending on *building* type, use *System* 5 or 7 in all climate zones.
- Public assembly *building* types include houses of worship, auditoriums, movie theaters, performance theaters, concert halls, arenas, enclosed stadiums, ice rinks, gymnasiums, convention centers, exhibition centers, and natatoriums.

ASHRAE Appendix G 90.1

- From ASHRAE Appendix G:
 - Building floor area
 - Number of floors
 - Building type

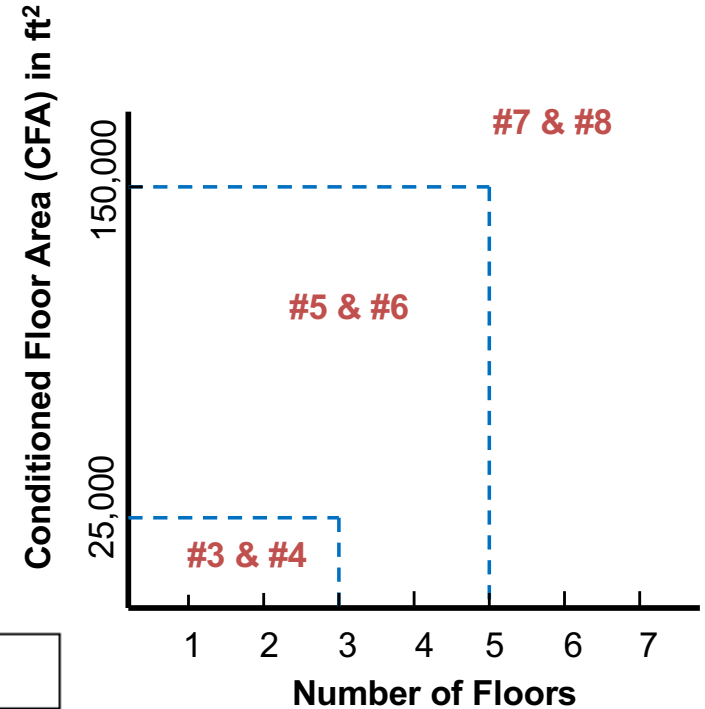

Building Type	Fossil Fuel, Fossil/Electric Hybrid, and Purchased Heat	Electric and Other
Residential	System 1—PTAC	System 2—PTHP
Nonresidential and 3 Floors or Less and <25,000 ft ²	System 3—PSZ-AC	System 4—PSZ-HP
Nonresidential and 4 or 5 Floors and <25,000 ft ² or 5 Floors or Less and 25,000 ft ² to 150,000 ft ²	System 5—Packaged VAV with Reheat	System 6—Packaged VAV with PFP Boxes
Nonresidential and More than 5 Floors or >150,000 ft ²	System 7—VAV with Reheat	System 8—VAV with PFP Boxes
Heated Only Storage	System 9—Heating and Ventilation	System 10—Heating and Ventilation

From: TABLE G3.1.1A Baseline HVAC System Types – ASHRAE Standard 90.1-10.

Note: PTAC – packaged terminal air conditioner PTHP – packaged terminal heat pump PSZ– packaged single zone VAV – variable air volume PFP – parallel fan power

Advanced Energy Design Guide (AEDG)

- This guideline:
 - Provide opportunities to save 30% or 50% (or net zero) site energy reductions when compared to those same facilities designed to meet the minimum code requirements of ANSI/ASHRAE/IESNA Standard 90.1-2004
 - Recommend design for a low-energy-use building and is not a minimum code or standard
 - Is a voluntary guidance document
 - Do not supplement, replace, or supersede existing codes and standards
 - Represents a way, but not the only way, to build energy-efficient small to medium office buildings with 50% energy savings

System Loops and Zone Equipment

- System loops vs. zone equipment
 - Loops:
 - Plant
 - Chilled water
 - Condenser
 - Air

 - Zone level

No. 1: PTAC & Baseboard

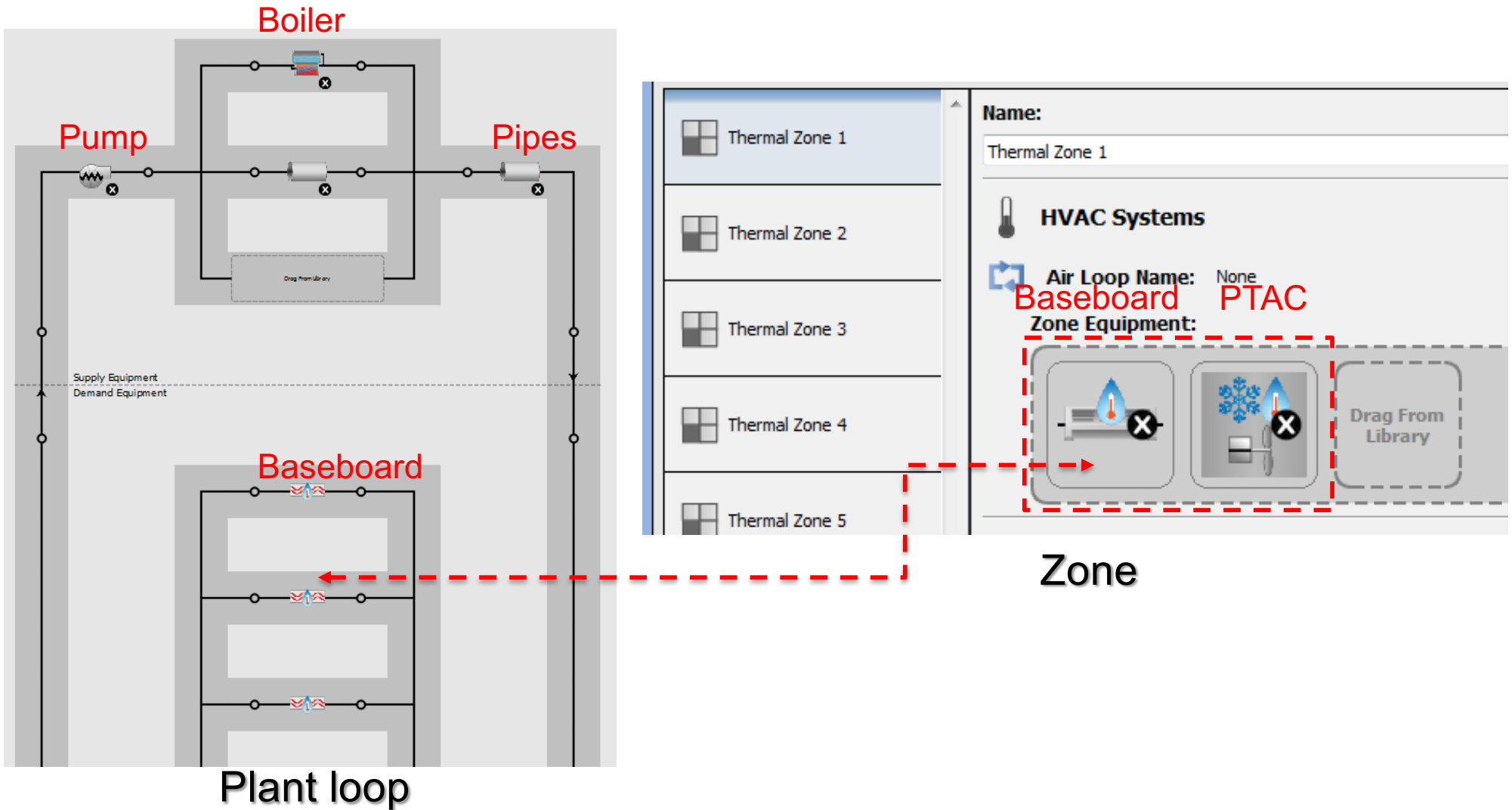

No. 1: PTAC & Baseboard

- Heating: Zone baseboard
- Cooling: PTAC

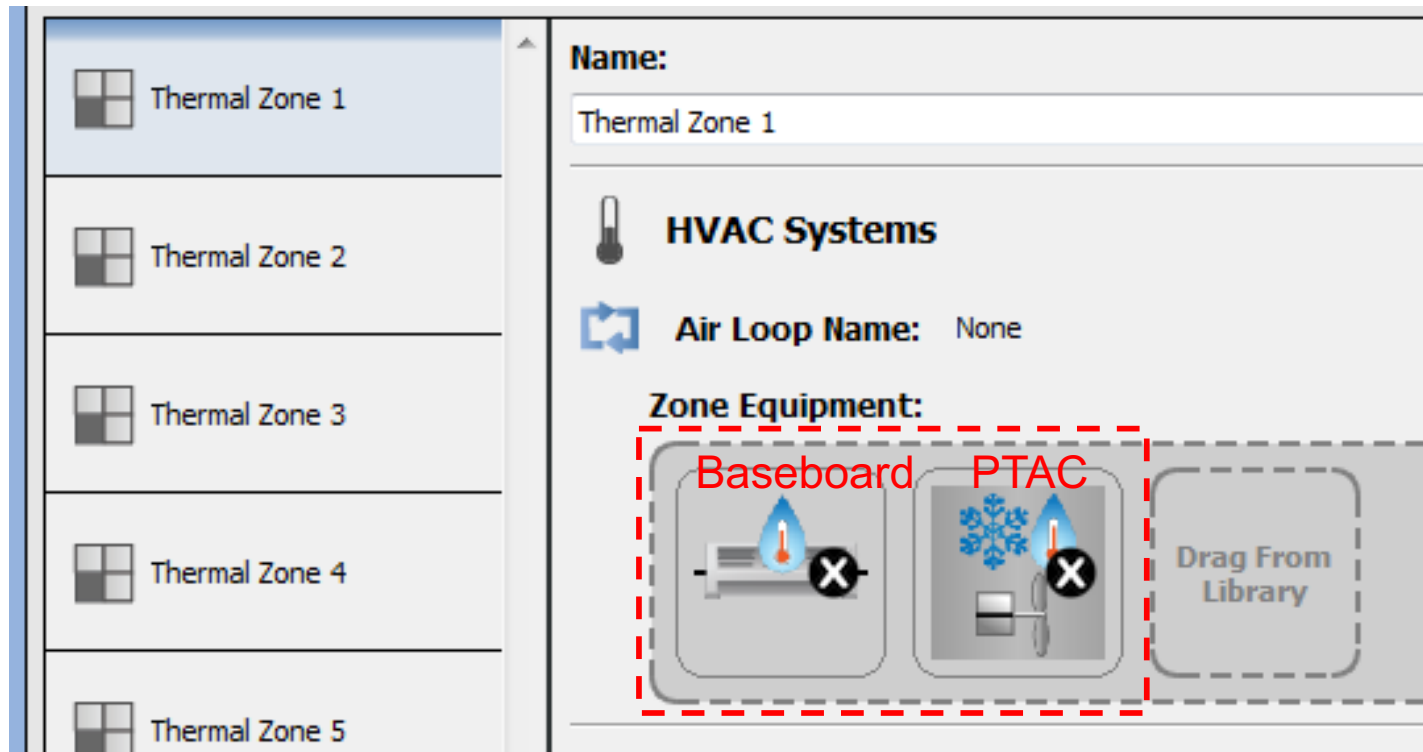

Zone

No. 1: PTAC & Baseboard

- Heating: Hot water plant loop

- Boiler
- Pump
- Pipes
- Baseboards

- Cooling: no need for any loop

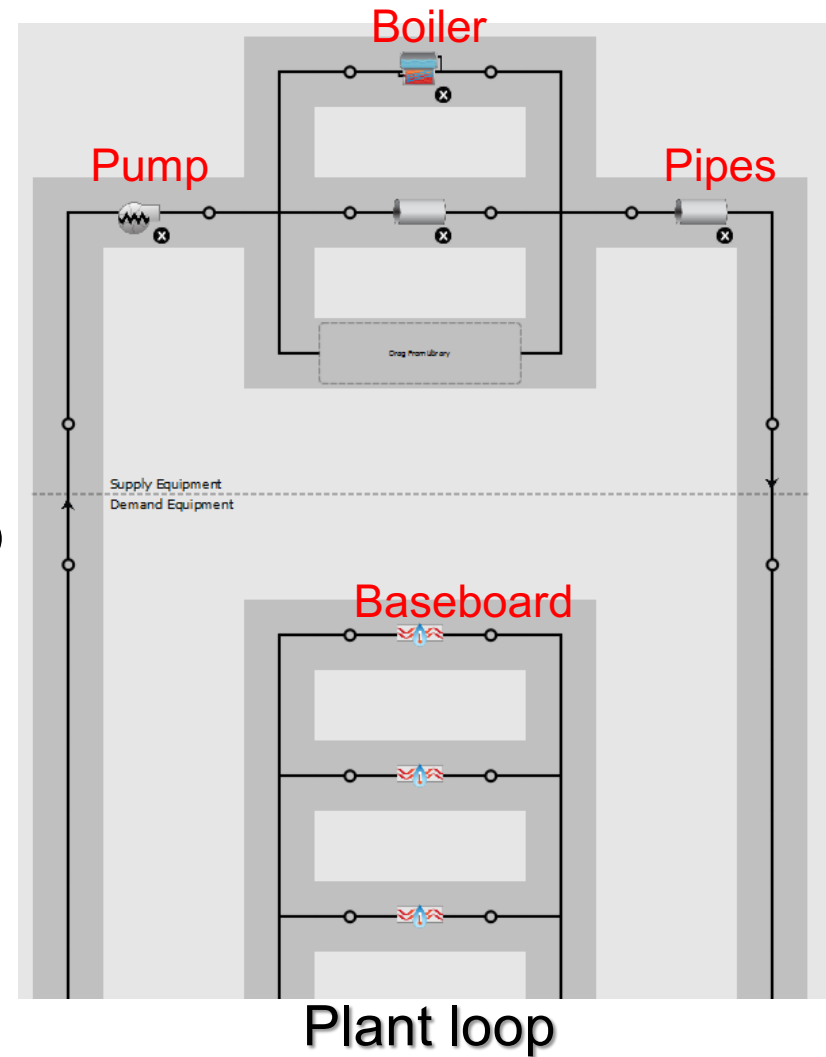

No. 1: PTAC

- Example:
 - ❑ LG PTAC 15,000 BTU with electric heat
 - ❑ Self-contained heating and AC system commonly found in hotels, condominiums, apartment buildings



No. 1: PTAC



No. 1: PTAC

- Hydronic vs electric baseboards considerations:
 - Initial cost
 - Energy efficiency
 - Performance (e.g., warm up, duration)



System No. 2: PTHP

- Packaged Terminal Heat Pump system includes only:
 - No loop
 - Zone level equipment

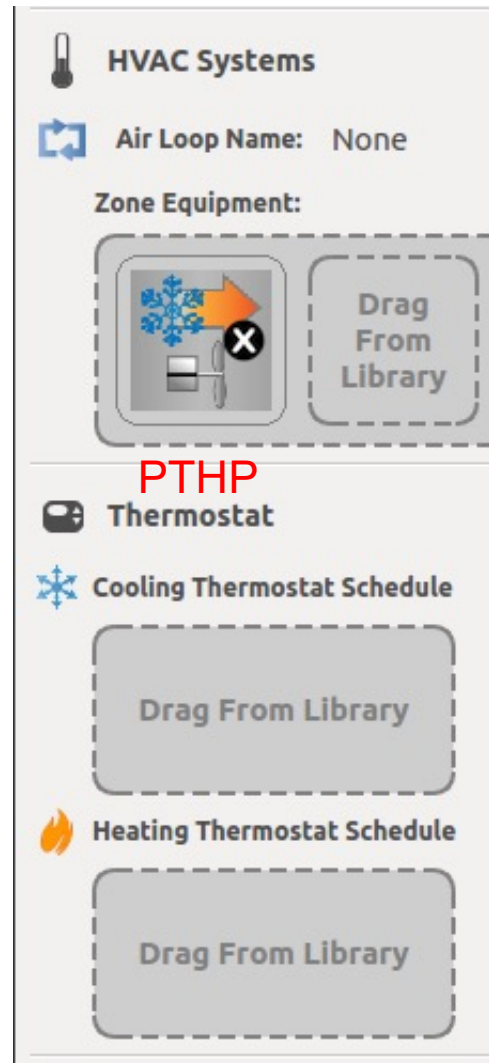

System No. 2: PTHP

- Radiative

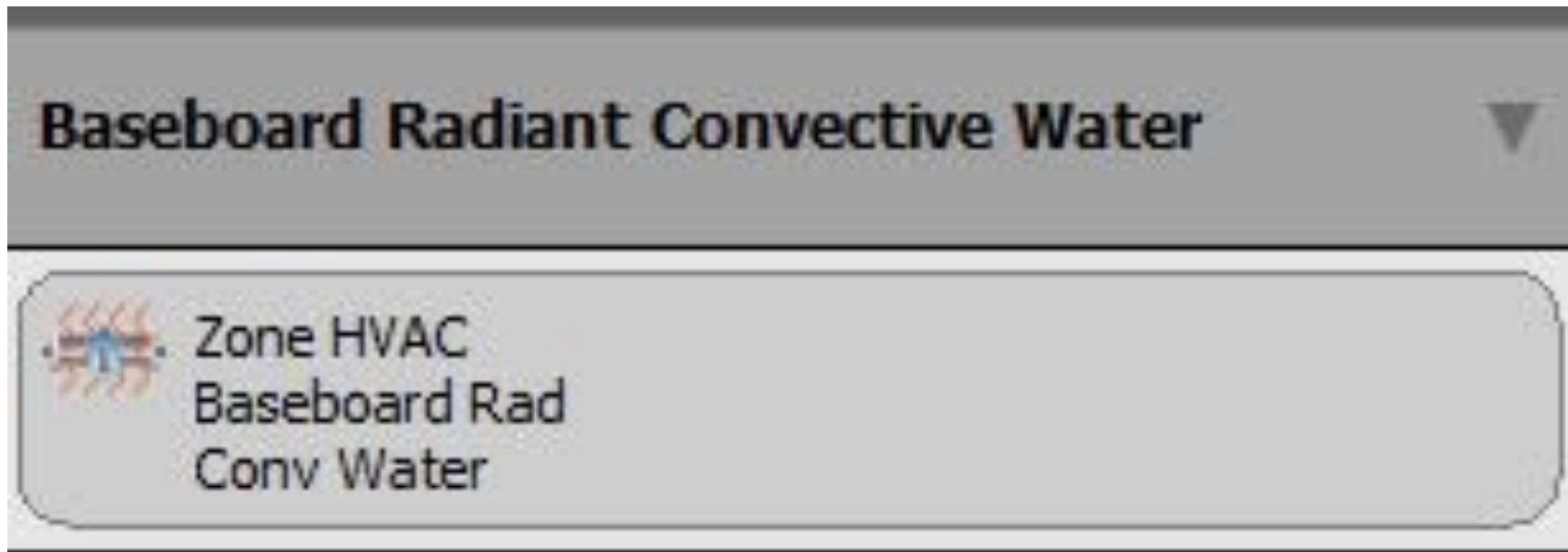

System No. 2: PTHP

- Example:
 - ❑ Amana 14,000 BTU (3.5 KW)
 - ❑ Automatic 2nd stage electric heat:
 - If the room temperature falls to 4 degrees below the set point temperature, the heat pump compressor is shut off and the electric heat strip is turned on
 - ❑ 3-Minute Compressor Lockout

**PACKAGE TERMINAL
AIR CONDITIONER/HEAT PUMP**
INSTALLATION INSTRUCTIONS & OWNER'S MANUAL
Standard and Remote Applications with LED Control

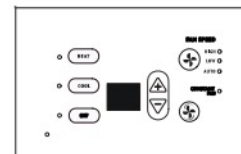
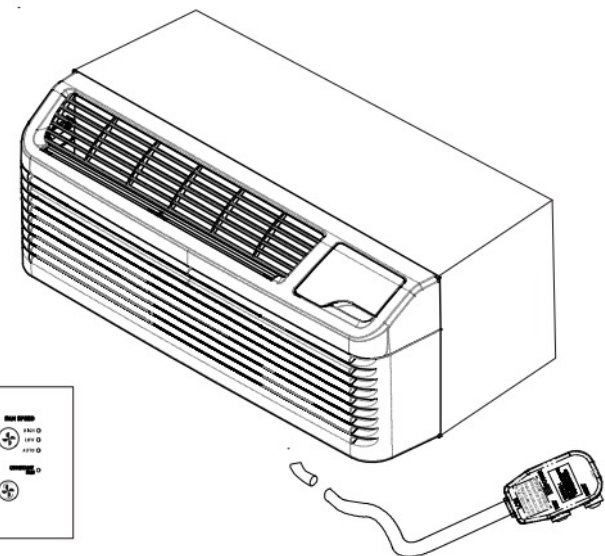

No. 3: Packaged Rooftop Air Conditioner

- This system has:
 - ❑ One air loop
 - ❑ Zone level equipment

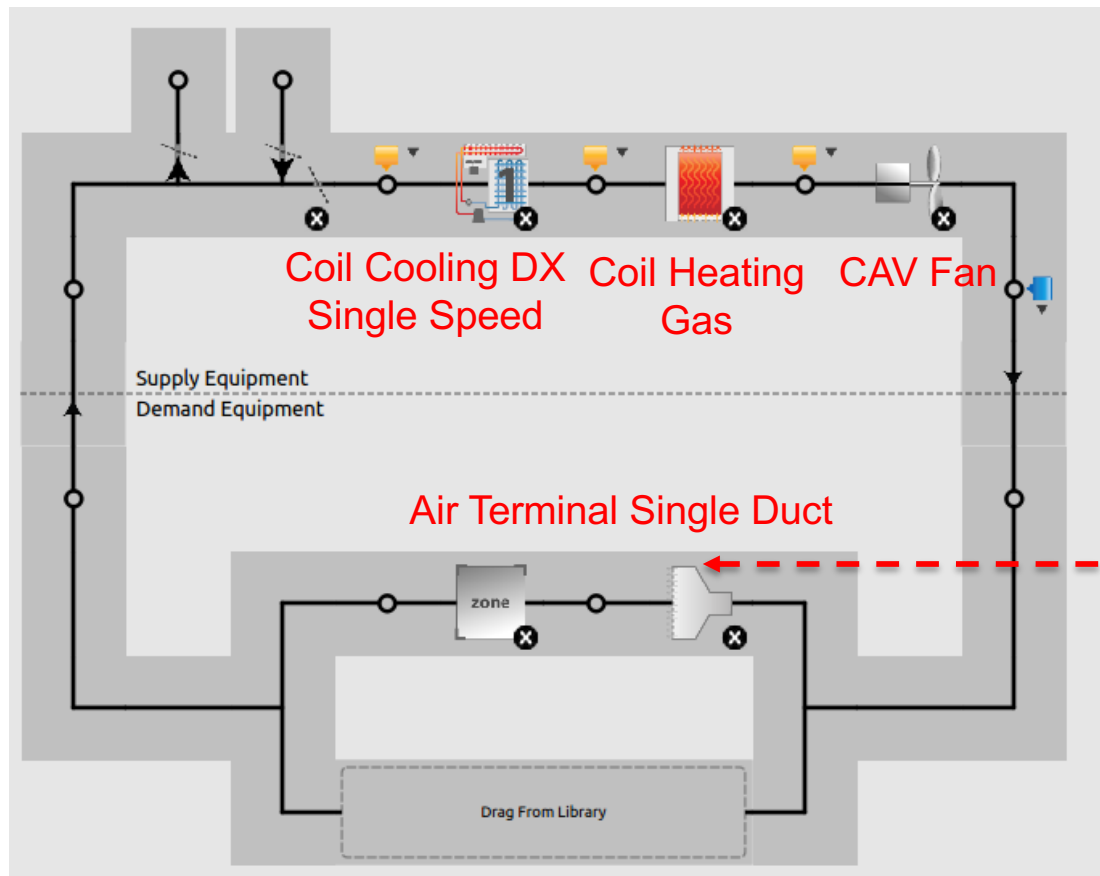

Air Loop

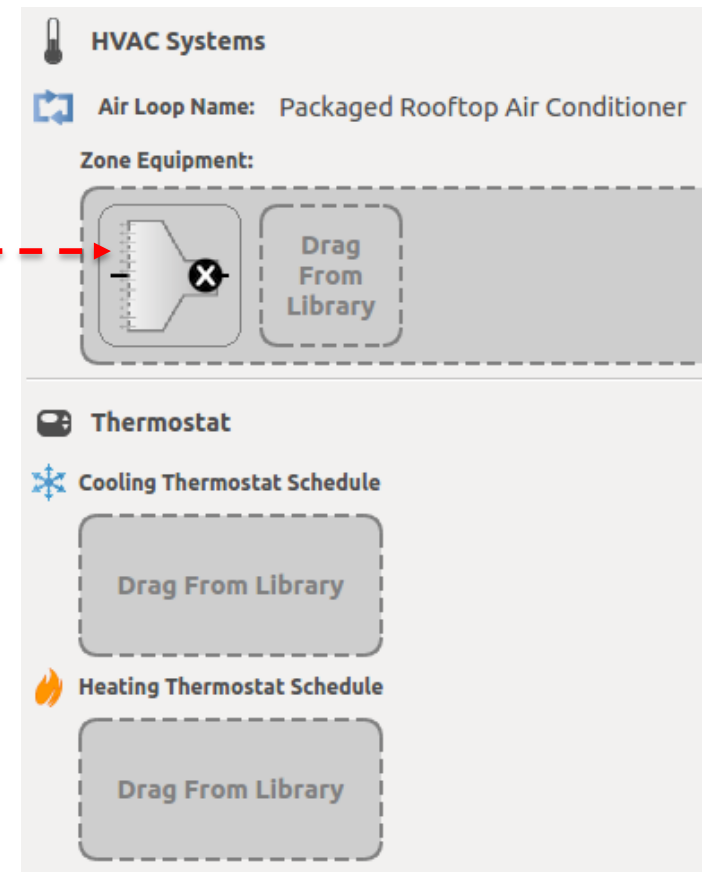

Zone Level

No. 3: Packaged Rooftop Air Conditioner

- Example:
 - ❑ Goodman 3.5 Ton 14 SEER 80,000 BTU Gas/Electric Package Unit
 - ❑ Refrigerant Type: R-410A



No. 4: Packaged Rooftop Heat Pump

- This system has:
 - ❑ One air loop
 - ❑ Zone level equipment

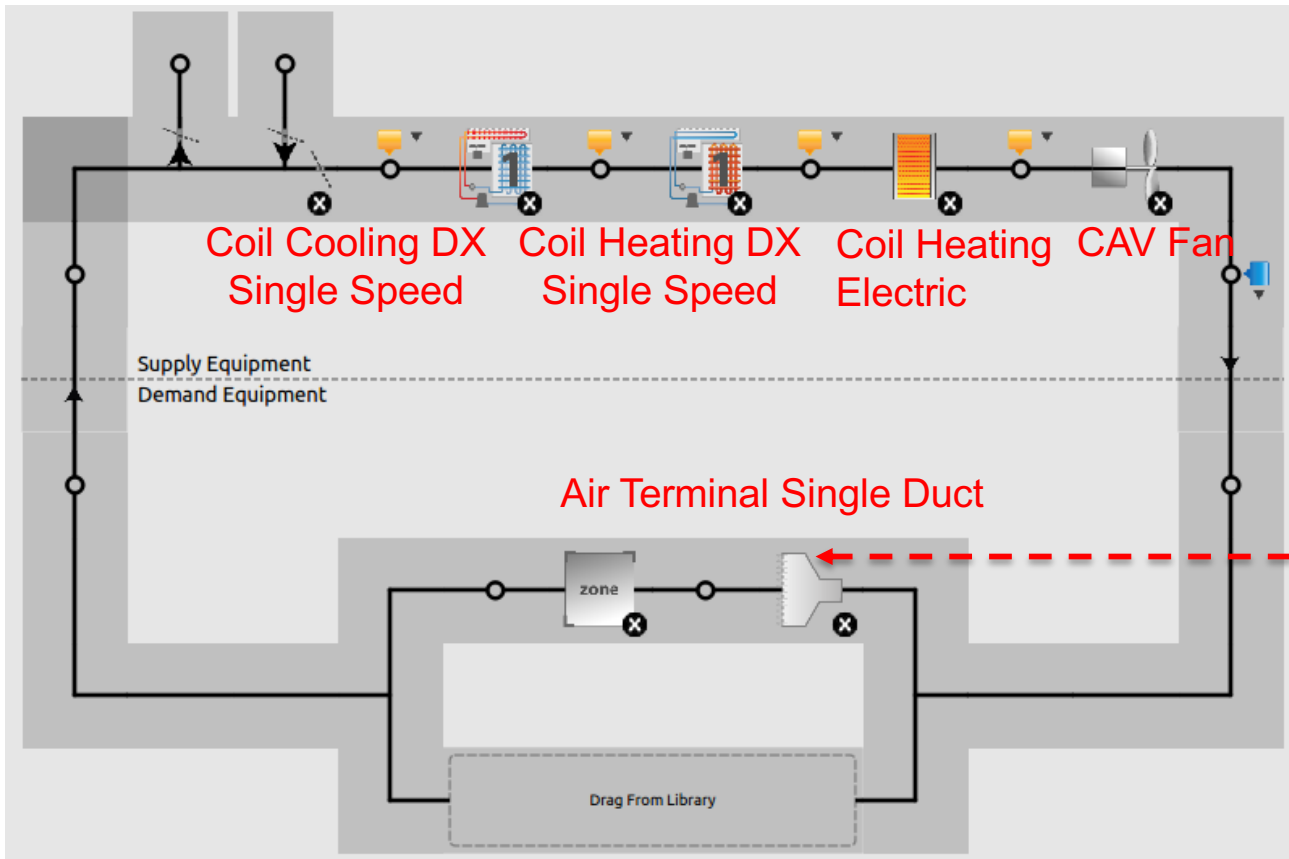

Air Loop

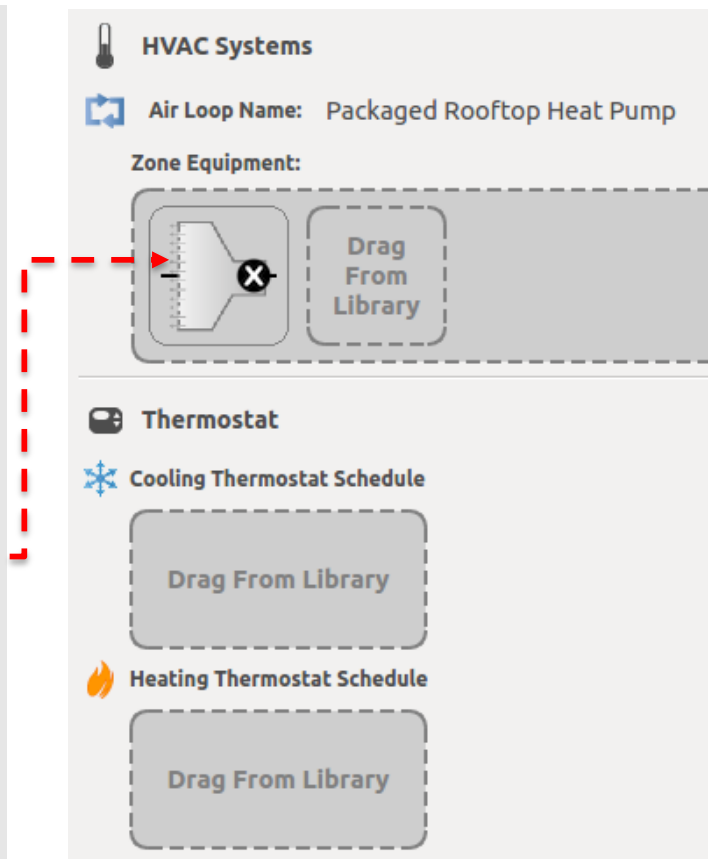

Zone Level

No. 4: Packaged Rooftop Heat Pump

- Example:
 - ❑ GOODMAN GPH1642H41
 - ❑ 3.5 Ton, 16 SEER Self-Contained Packaged Heat Pump, Dedicated Horizontal



No. 5: Packaged VAV with Reheat

- Packaged VAV with Reheat:
 - ❑ One air loop
 - ❑ One plant loop
 - ❑ Zone level equipment

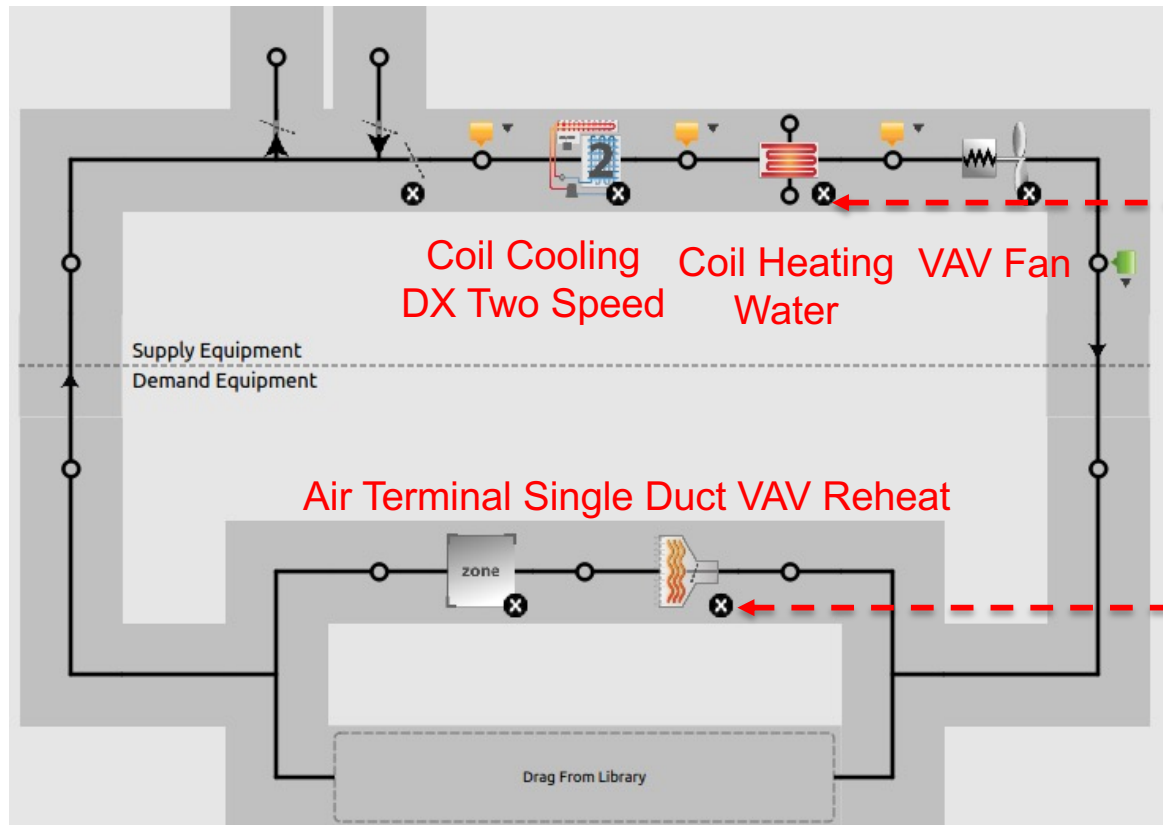

Air loop

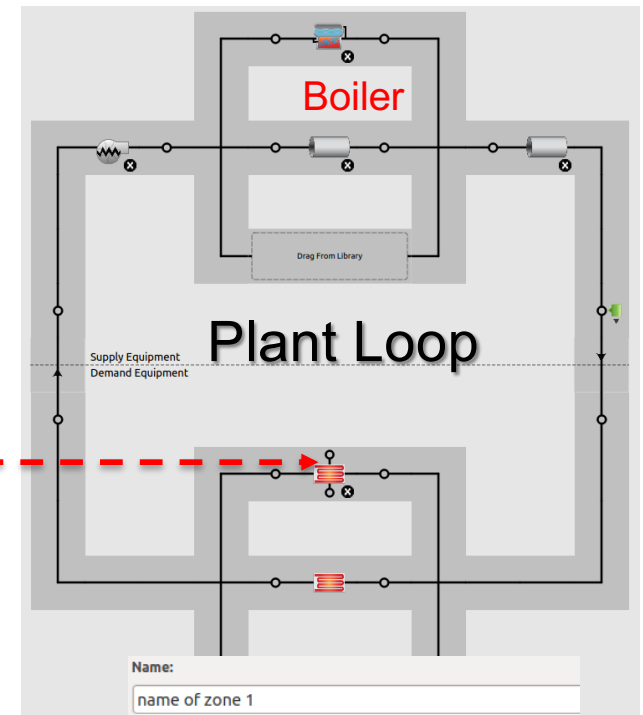

Name: name of zone 1

HVAC Systems

Air Loop Name: Packaged Rooftop VAV with Reheat

Zone Equipment:

Thermostat

Cooling Thermostat Schedule

Heating Thermostat Schedule

Zone

No. 5: Packaged VAV with Reheat

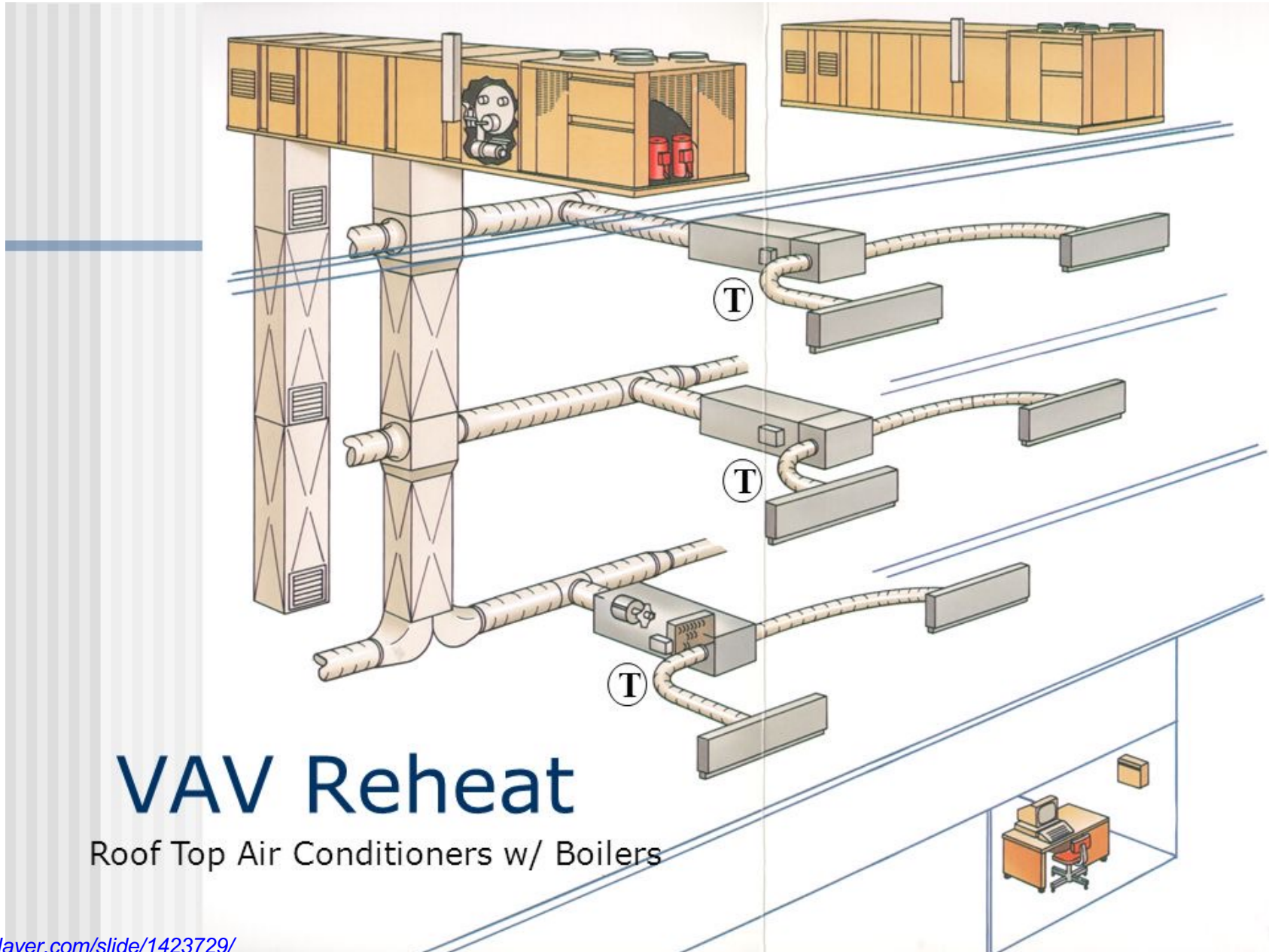

VAV Reheat
Roof Top Air Conditioners w/ Boilers

No. 5: Packaged VAV with Reheat

- Using economizer based on ASHRAE 90.1 Appendix G:

TABLE G3.1.2.6 Climate Conditions under which Economizers are Included for Comfort Cooling for Baseline Systems 3 through 8 and 11, 12, and 13

Climate Zone	Conditions
1a, 1b, 2a, 3a, 4a	NR
Others	Economizer Included

Note: NR means that there is no conditioned building floor area for which economizers are included for the type of zone and climate.

No. 6: Packaged Rooftop VAV with PFP Boxes & Reheat

- Packaged Rooftop VAV with PFP Boxes and Reheat has:
 - One air loop
 - Zone level equipment

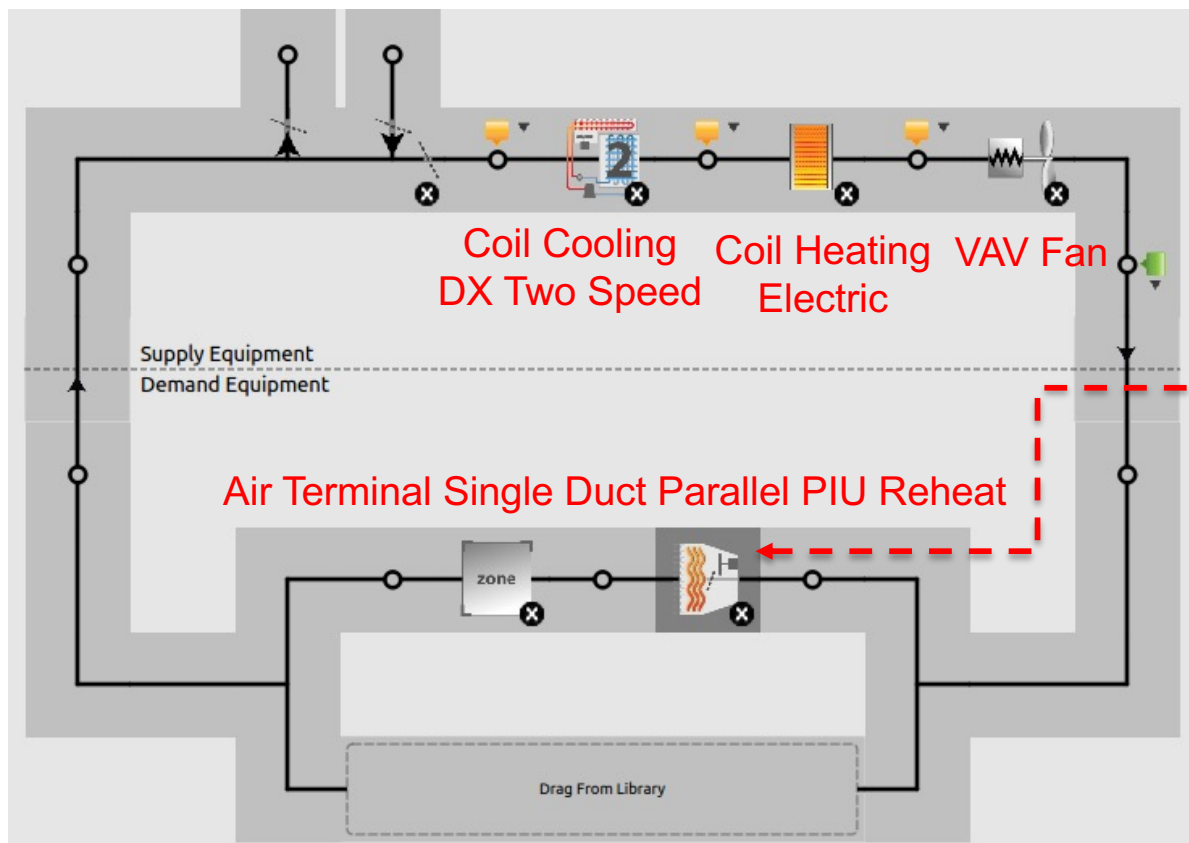

Air Loop

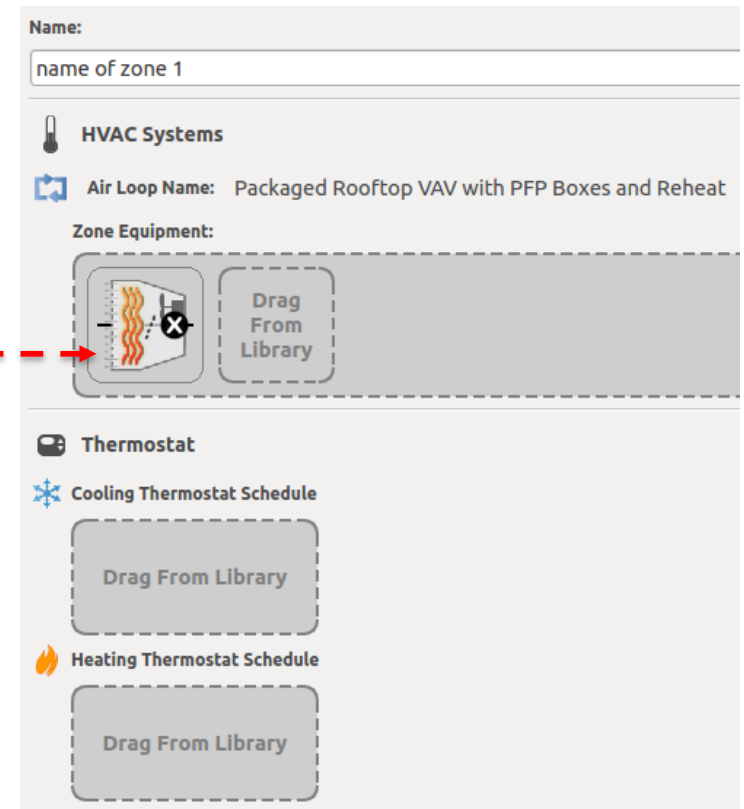

Zone Level

No. 6: Packaged Rooftop VAV with PFP Boxes & Reheat

- Fan Powered Boxes:
 - ❑ **Series:** fan-powered terminals have fans that must run throughout the occupied mode in order to deliver ventilation air to the zone:
 - Act as boosters for the air handler
 - Move the air the rest of the way to the zone
 - Allow AHU to run at system pressure far lower than other type of terminals
 - Provide constant air and more air changes than other type of terminals
 - Have constant sound levels, unlike other types of terminal units that vary air volumes and/or cycle fans
 - ❑ **Parallel:** Parallel fan-powered terminals have fans that only switch on during the heating mode to pull warm return air from ceiling plenum:
 - The unit fan is off during the cooling mode
 - Some engineers do not specify parallel fan units because the fan cycling is often noticeable to occupants

No. 7: Packaged Roof + Chiller

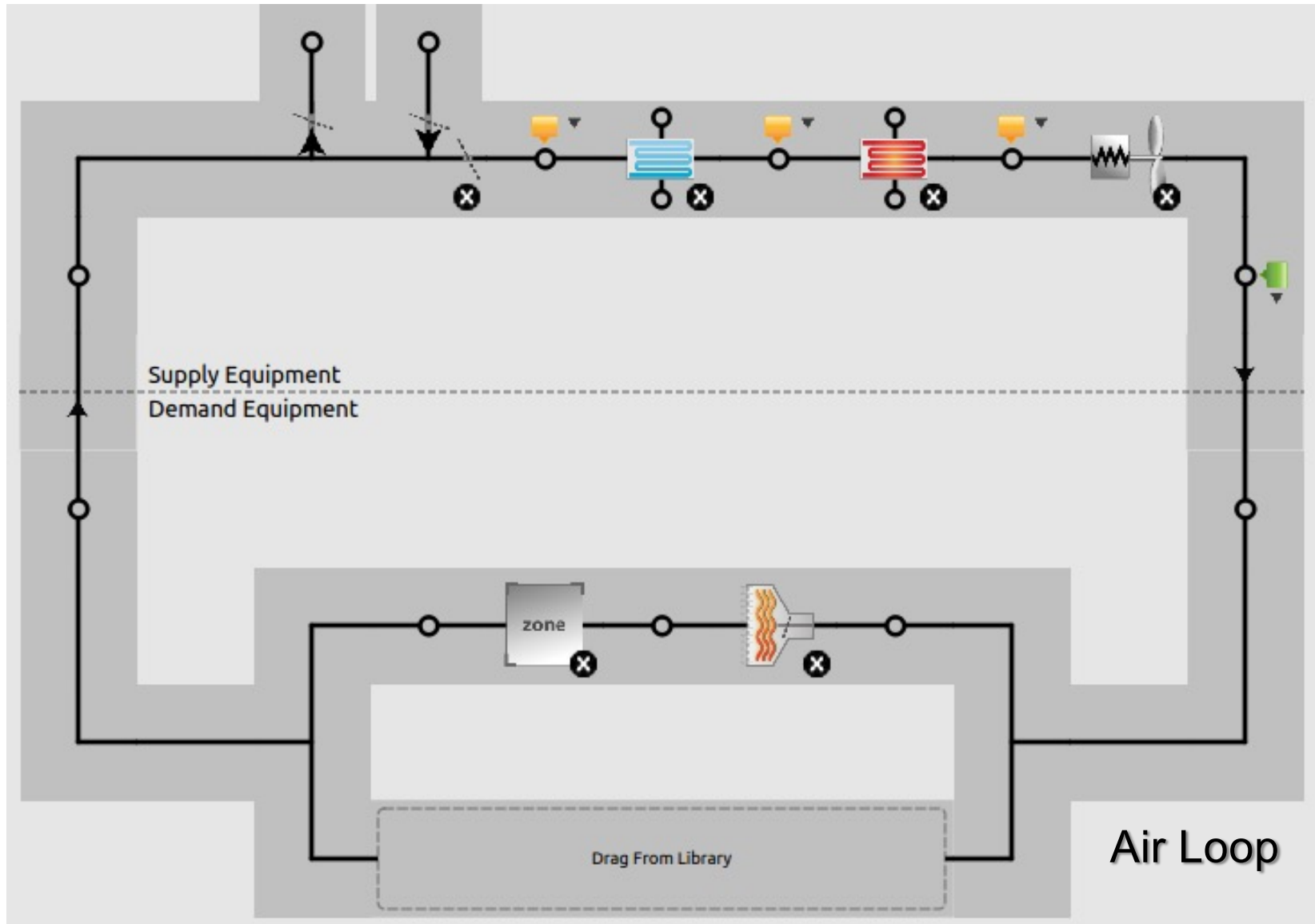

How many loops should we have?

No. 7: Packaged Roof + Chiller

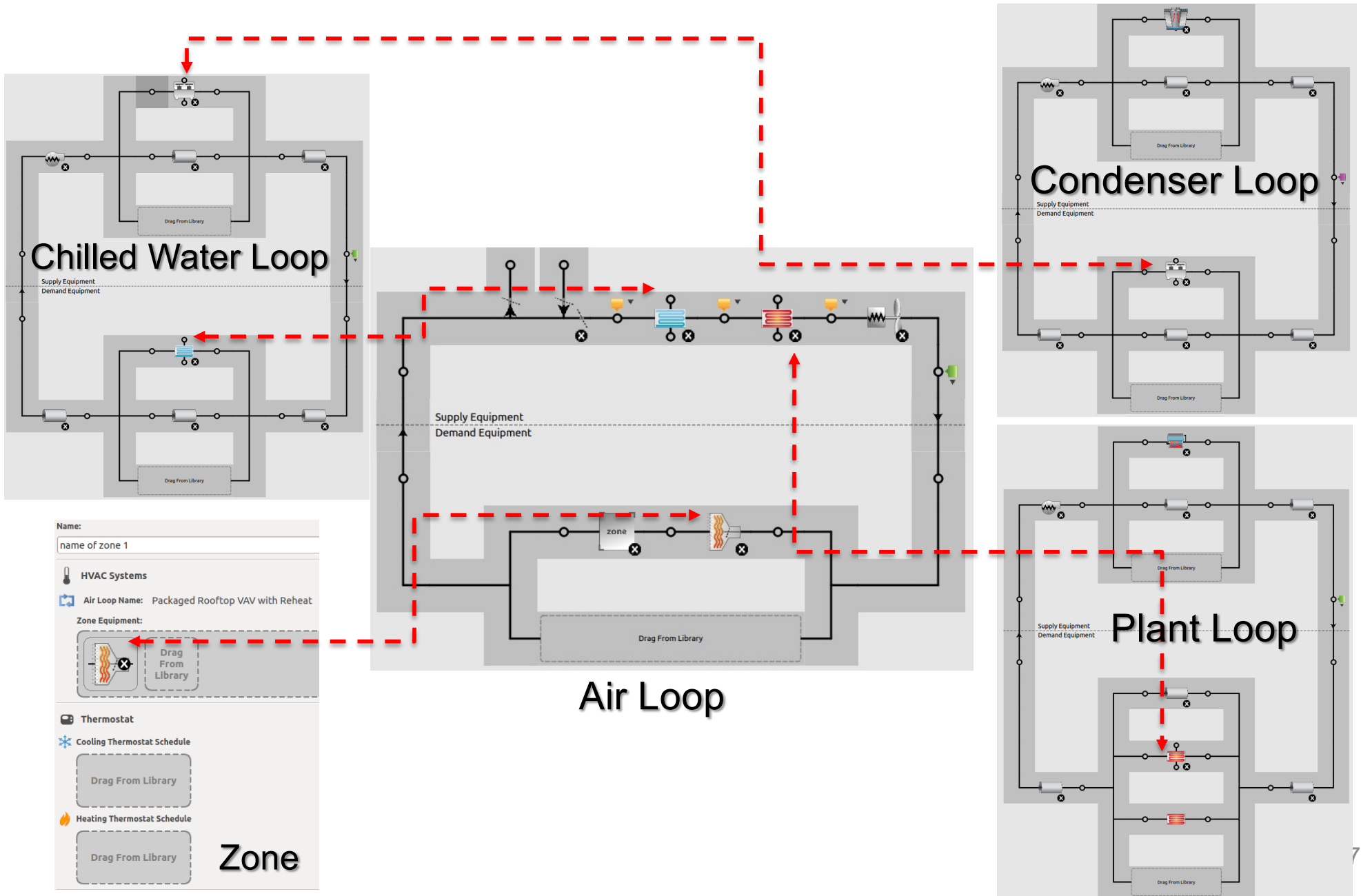

No. 7: Packaged Roof + Chiller

- Air loop
 - Cooling coil
 - Heating coil
 - Fan
 - Setpoint
 - Zone
 - Terminal

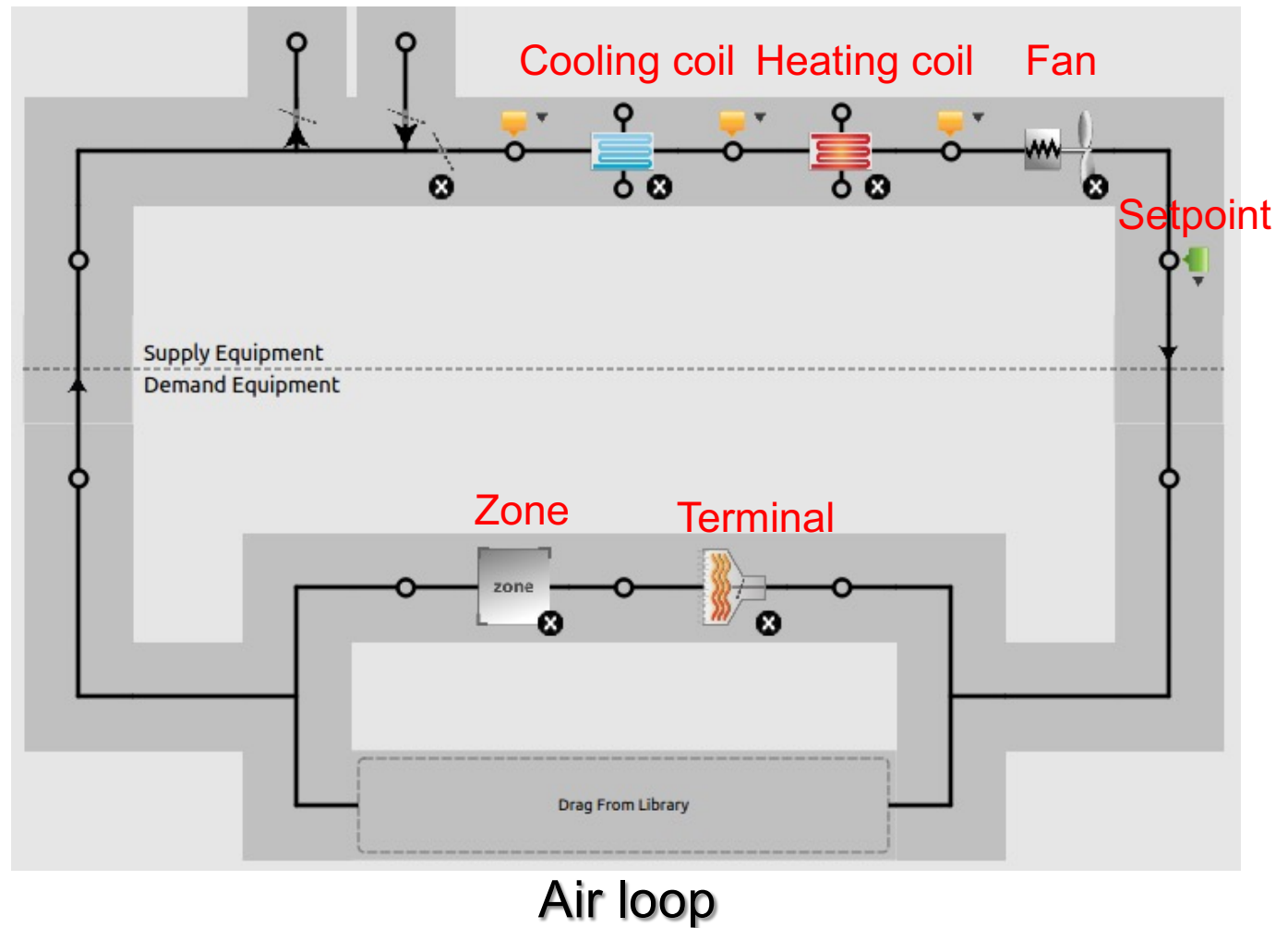

No. 7: Packaged Roof + Chiller

- Plant Loop
 - Boiler
 - Fan
 - Pipes
 - Heating Coil

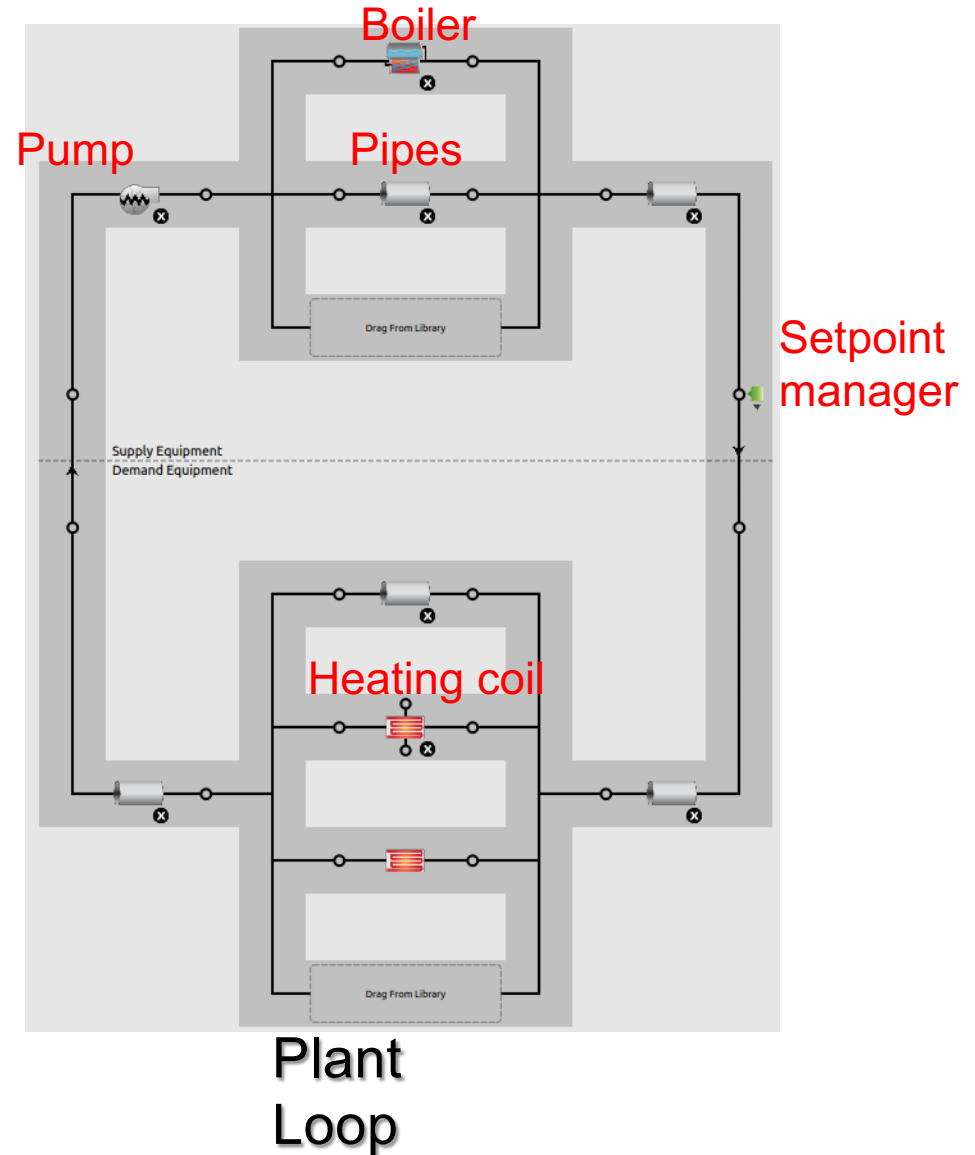

No. 7: Packaged Roof + Chiller

- Condenser Loop
 - Cooling Tower
 - Fan
 - Pipes
 - Chiller

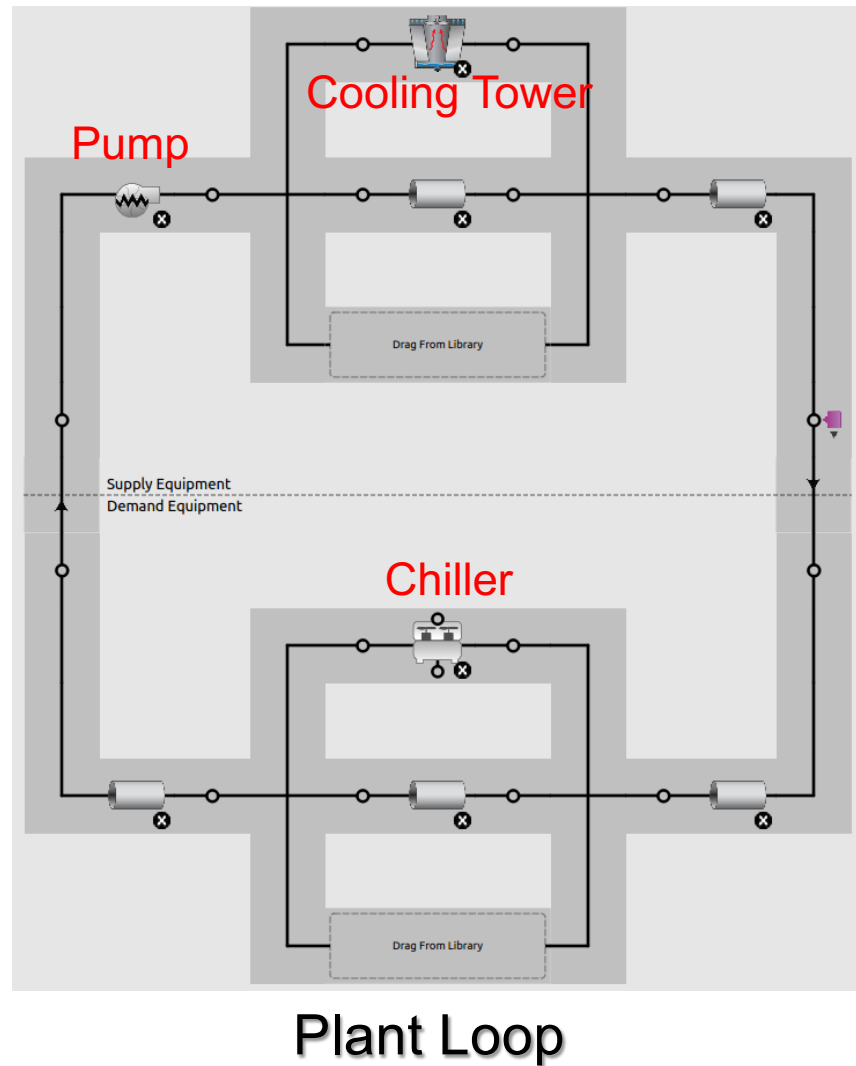

No. 7: Packaged Roof + Chiller

- Chilled water Loop
 - Chiller
 - Fan
 - Pipes
 - Cooling coil

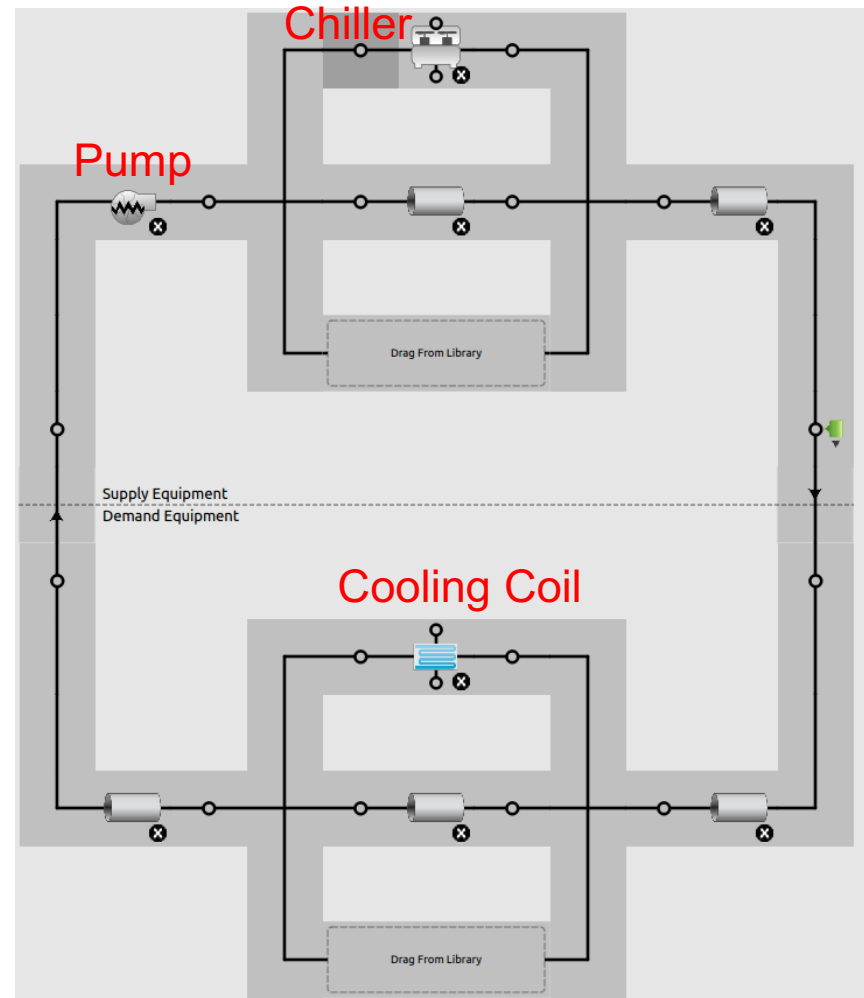

Chilled water Loop

No. 7: Packaged Roof + Chiller

- Number and type of chillers based on ASHRAE 90.1 Appendix G:

TABLE G3.1.3.7 Type and Number of Chillers

Building Peak Cooling Load	Number and Type of Chiller(s)
≤300 tons	1 water-cooled screw chiller
>300 tons, <600 tons	2 water-cooled screw chillers sized equally
≥600 tons	2 water-cooled centrifugal chillers minimum with chillers added so that no chiller is larger than 800 tons, all sized equally

No. 8: VAV with PFP Boxes and Reheat

- This system has:

- One air loop
- One plant loop
- Zone level

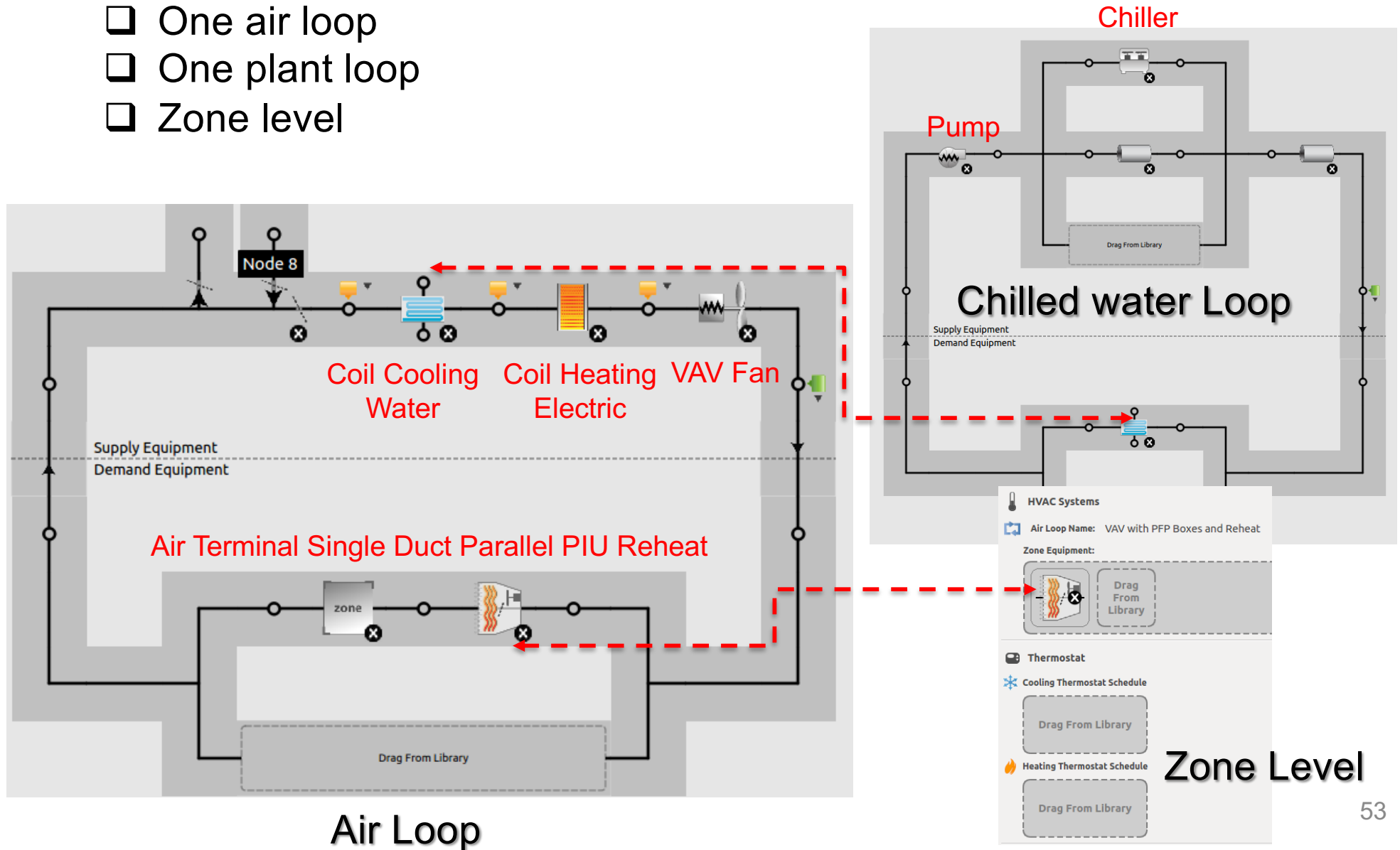

No. 9: VAV with PFP Boxes and Reheat

- This system includes only:
 - An air loop
 - Zone level

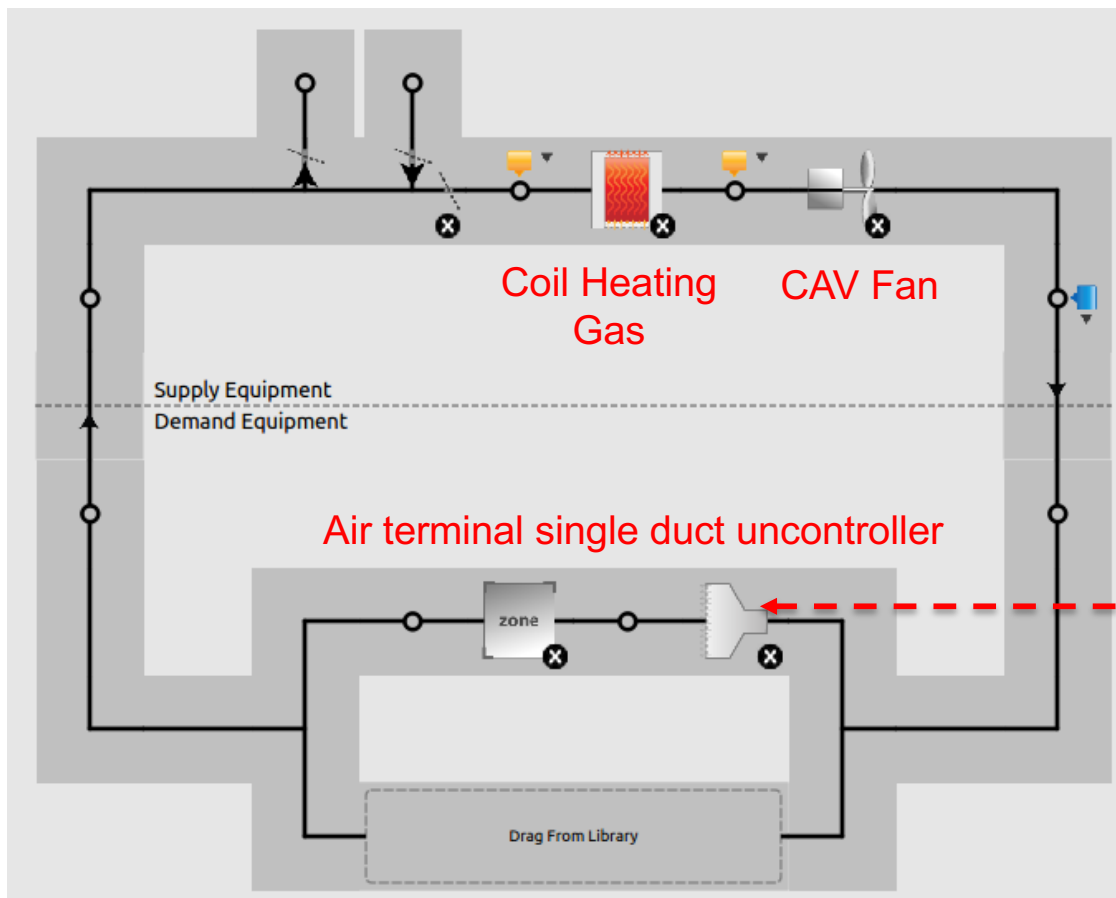

Air Loop

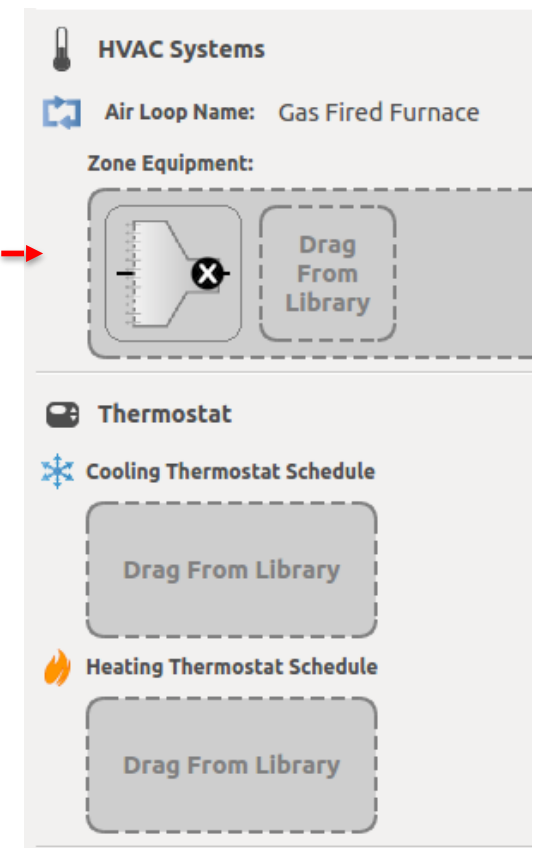

Zone Level

No. 10: Electric Furnace

- This system includes only:
 - An air loop
 - Zone level

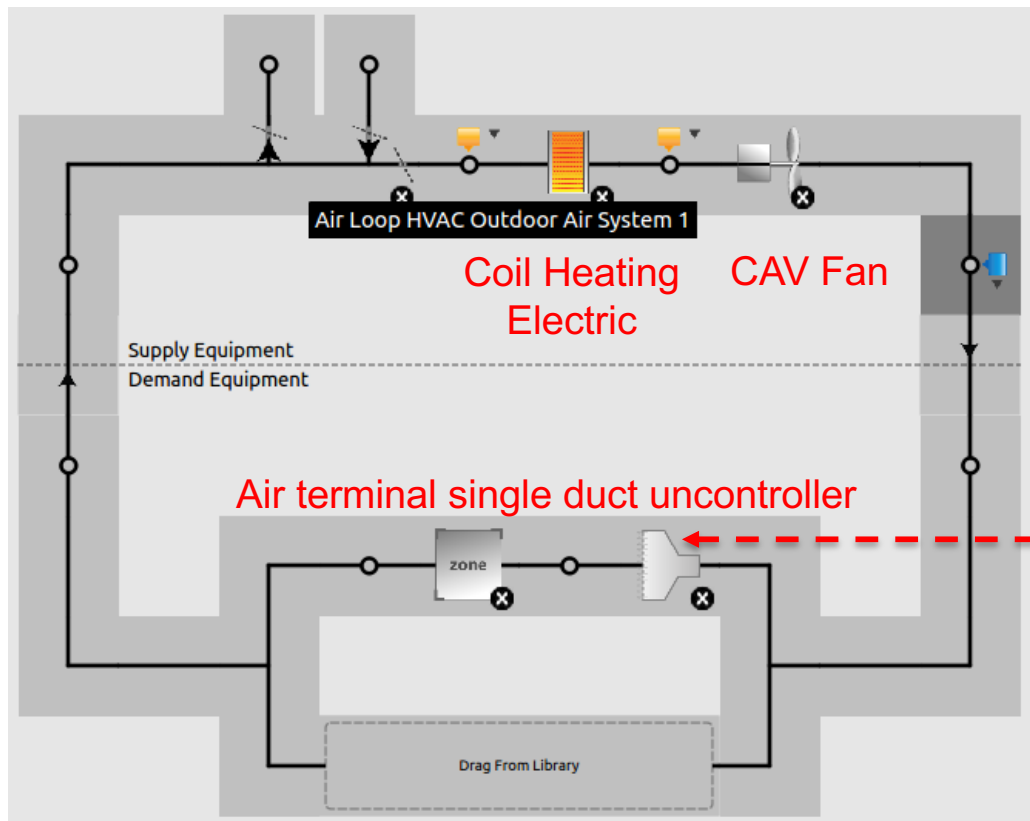

Air Loop

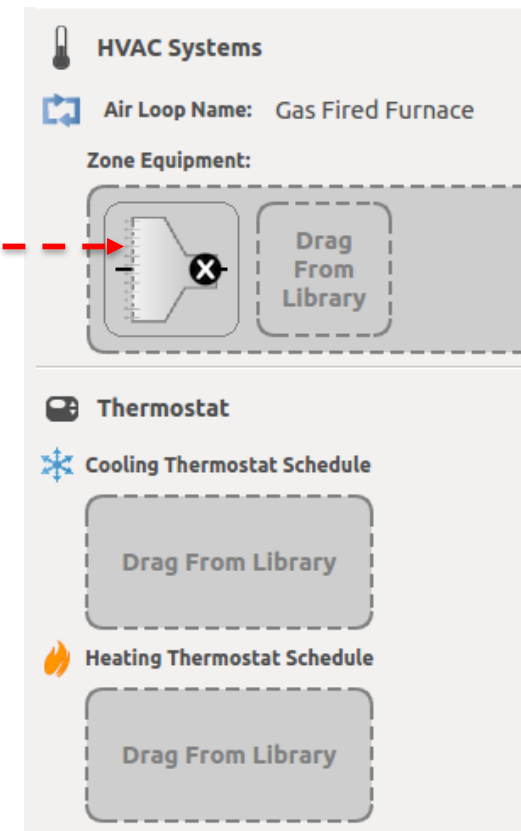

Zone Level

No. 10: Electric Furnace

- It includes a blower and a heater:

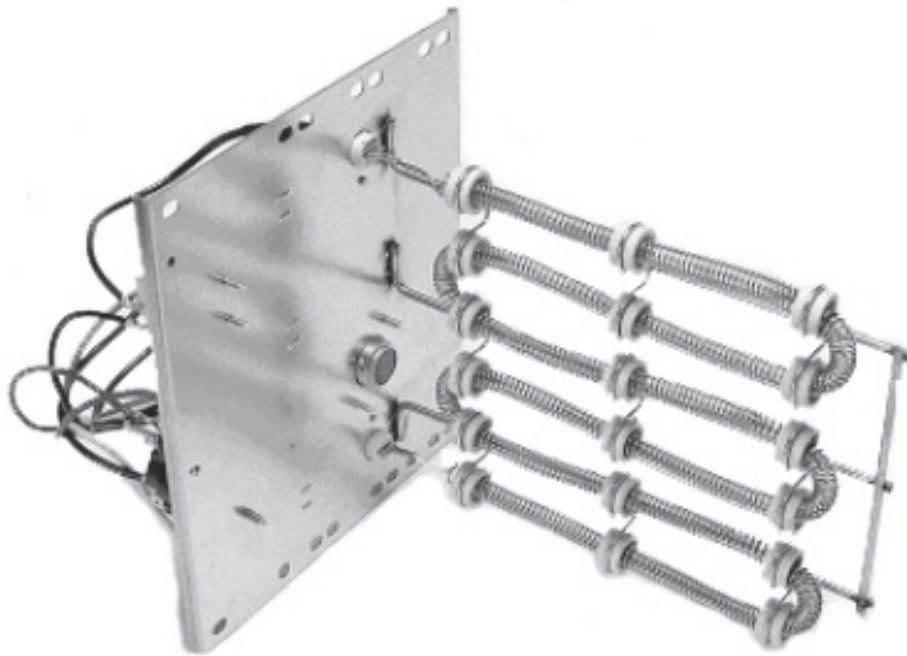

ASHRAE ADVANCED ENERGY DESIGN GUIDES

Advanced Energy Design Guide (AEDG)

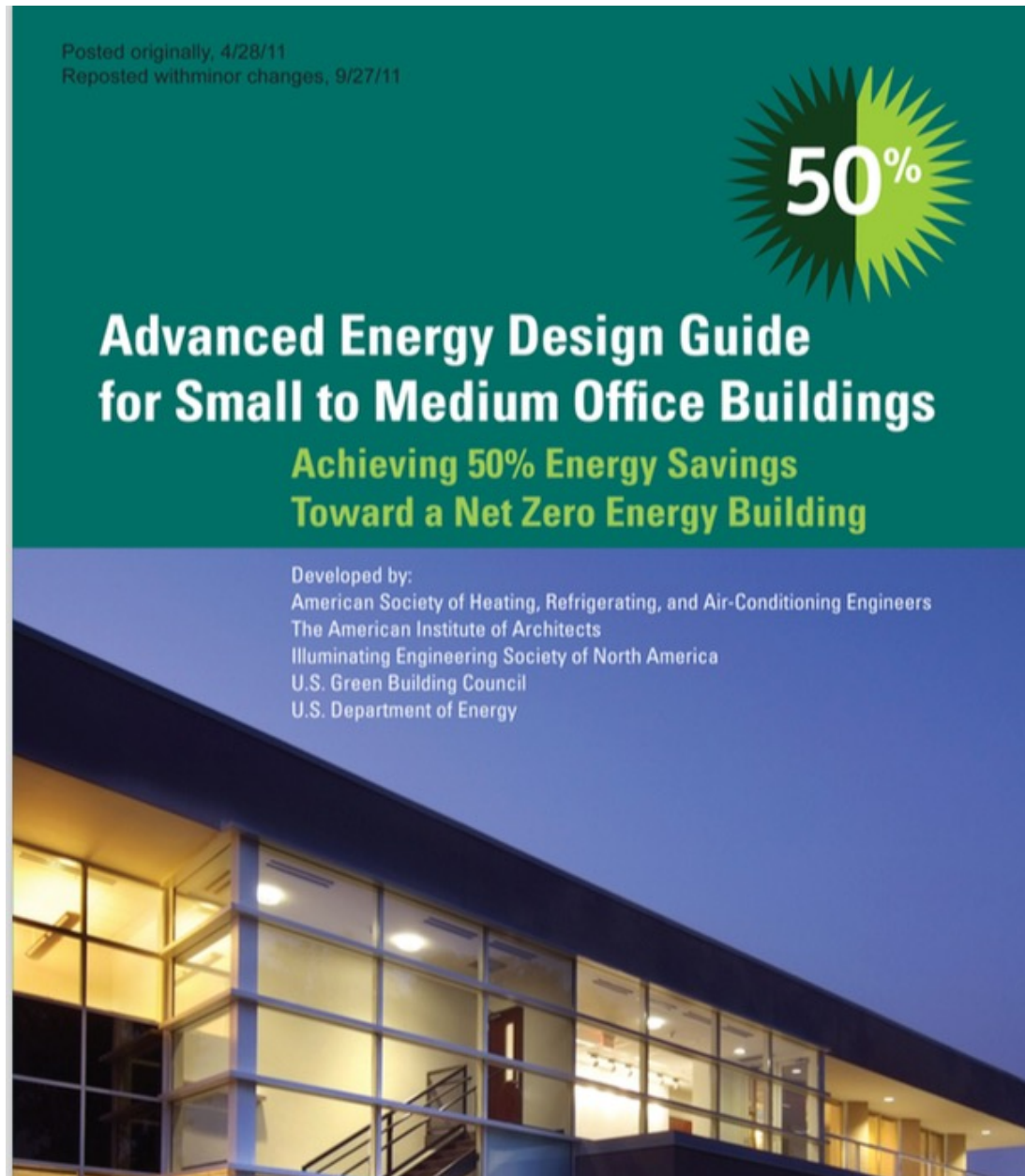

Advanced Energy Design Guide

Reference System No.	Ventilation Type	Cooling Type	Heating Type	Additional Information
1	DOAS	Air-source heat pump	Heat pump w/ electric supplemental heating	Packaged single zone unit
2	DOAS	Water-source heat pump or Ground-source heat pump	Heat pump	Packaged single zone unit
3	MZ VAV	DX	(1) Hydronic system; (2) Indirect gas furnace; or (3) Inter electric heating w/ perimeter electric convection heating	Packaged rooftop units
4	MZ VAV	Air-cooled chiller	Gas-fired boiler	Air-handling units
5	DOAS	Air-cooled chiller	Gas-fired boiler	Fan-coils system
6	DOAS	Air-cooled chiller	Condensing boiler	Radiant system

Advanced Energy Design Guide

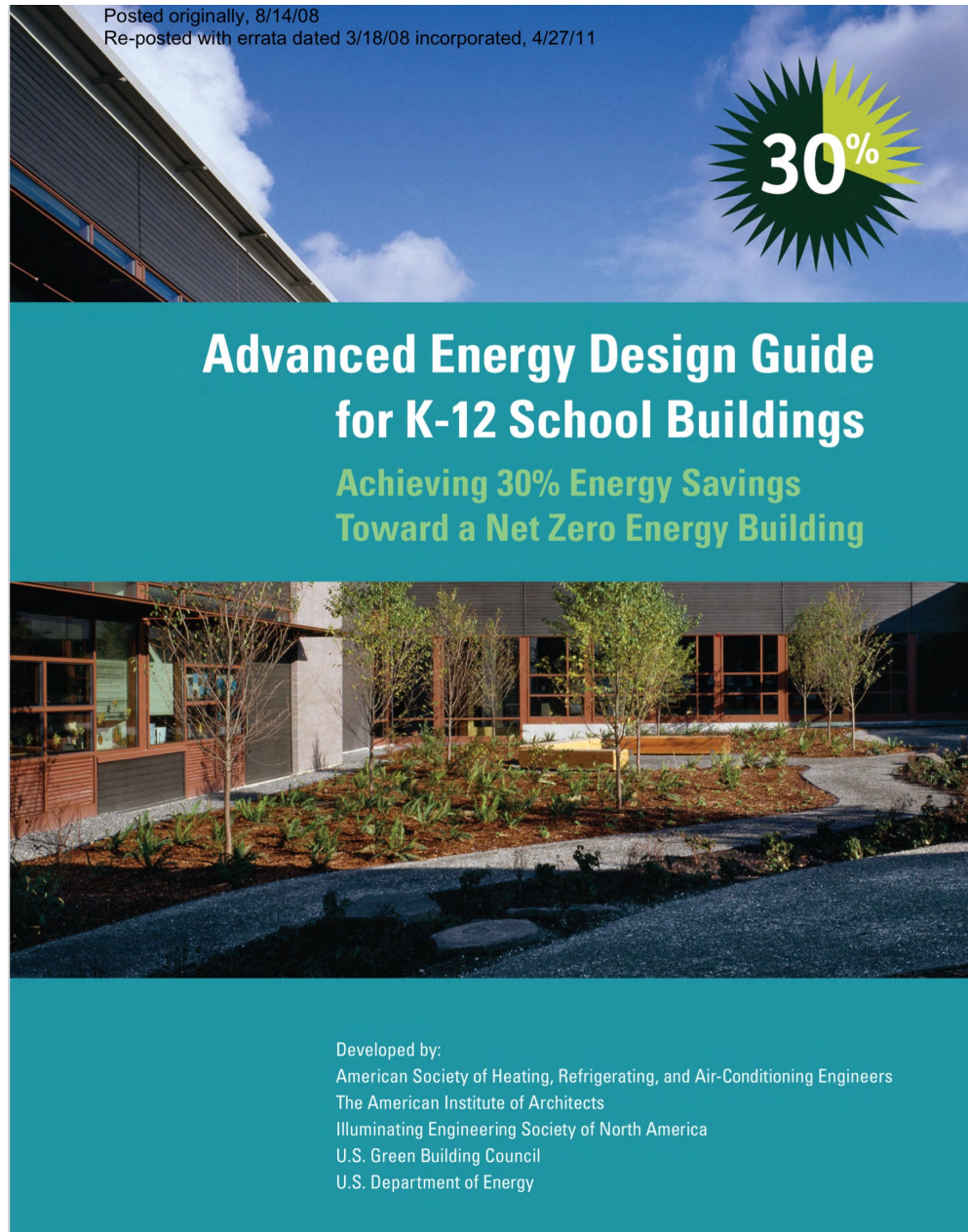

Advanced Energy Design Guide

Posted originally, 9/28/2011
Reposted with errata dated 2/19/14 incorporated, 2/19/2014



Advanced Energy Design Guide for K-12 School Buildings

**Achieving 50% Energy Savings
Toward a Net Zero Energy Building**

Developed by:
American Society of Heating, Refrigerating and Air-Conditioning Engineers
The American Institute of Architects
Illuminating Engineering Society of North America
U.S. Green Building Council
U.S. Department of Energy



Advanced Energy Design Guide

Posted originally, 1/11/2018
Reposted with errata dated 1/31/18 incorporated, 2/1/2018

ACHIEVING
ZERO ENERGY

**Advanced Energy Design Guide
for K-12 School Buildings**



Developed by:
ASHRAE
The American Institute of Architects
Illuminating Engineering Society
U.S. Green Building Council
U.S. Department of Energy

Advanced Energy Design Guide

Climate Zone 5 Recommendation Table for K-12 School Buildings

	Item	Component	Recommendation	How-to Tips	✓
Envelope	Roofs	Insulation entirely above deck	R-30.0 c.i.	EN2,17,19,21,22	
		Attic and other	R-49.0	EN3,17,19,20,21	
		Metal building	R-25.0 + R-11 L_g	EN4,17,19,21,22	
		Solar Reflectance Index (SRI)	Comply with Standard 90.1*		
	Walls	Mass (HC > 7 Btu/ft ²)	R-13.3 c.i.	EN5,17,19,21	
		Steel framed	R-13.0 + R-15.6 c.i.	EN6,17,19,21	
		Wood framed and other	R-13.0 + R-10.0 c.i.	EN7,17,19,21	
		Metal building	R-0.0 + R-19.0 c.i.	EN8,17,19,21	
	Floors	Below grade walls	R-7.5 c.i.	EN9,17,19,21,22	
		Mass	R-14.6 c.i.	EN10,17,19,21	
		Steel framed	R-38.0	EN11,17,19,21	
		Wood framed and other	R-38.0	EN11,17,19,21	
	Slabs	Unheated	Comply with Standard 90.1*	EN17,19,21	
		Heated	R-20 for 24 in.	EN13,14,17,19,21,22	
	Doors	Swinging	U-0.50	EN15,17	
		Nonswinging	U-0.50	EN16,17	
	Vestibules	At building entrance	Yes	EN17,18	
		Thermal transmittance	Nonmetal framing = U-0.35 Metal framing = U-0.44	EN24	
View Fenestration	Fenestration-to-floor-area ratio (FFR)	E or W orientation = 5% maximum N or S orientation = 7% maximum	EN24-25		
	Solar heat gain coefficient (SHGC)	E or W orientation = 0.42 N orientation = 0.62 S orientation = 0.75	EN24,32-33		
Daylight Fenestration	Exterior sun control	S orientation only = PF-0.5	EN26,33		
	Visible transmittance (VT)	See Table 5-5 for appropriate VT value	DL1,5-6,23		
Daylighting	Interior/exterior sun control (S orientation only)	S orientation = no glare during school hours	DL1,9,12,13,31		
	Classroom, resource rooms, cafeteria, gym, and multipurpose rooms	Daylight 100% of floor area for 2/3 of school hours	DL1-5,7-21,24-30,32-41		
Daylighting/Lighting	Interior Finishes	Administration areas	Daylight perimeter floor area (15 ft) for 2/3 of school hours	DL1-5,8-12	
		Interior surface average reflectance for daylighted rooms	Ceilings = 80% Wall surfaces = 70%	DL14	
	Lighting power density (LPD)	Whole building = 0.70 W/ft ² Gyms, multipurpose rooms = 1.0 W/ft ² Classrooms, art rooms, kitchens, libraries, media centers = 0.8 W/ft ² Cafeterias, lobbies = 0.7 W/ft ² Offices = 0.60 W/ft ² Auditoriums, restrooms = 0.5 W/ft ² Corridors, mechanical rooms = 0.4 W/ft ²	EL12-19		
		Light source lamp efficacy (mean lumens per watt)	T8 & T5 > 2 ft = 92, T8 & T5 ≤ 2 ft = 85, All other > 50	EL4-6	
	Interior Lighting	T8 ballasts	Non-dimming = NEMA Premium Instant Start Dimming = NEMA Premium Program Start	EL4-6	
		T5/T5HO ballasts	Electronic program start		
		CFL and HID ballasts	Electronic		
		Dimming controls daylight harvesting	Dim all fixtures in daylight zones	EL8,9,11-19	
	Exterior Lighting	Lighting controls	Manual ON, auto/timed OFF in all areas as possible	EL8,9,11-20	
		Facade and landscape lighting	LPD = 0.075 W/ft ² in LZ-3 & LZ-4 LPD = 0.05 W/ft ² in LZ-2 Controls = auto OFF between 12am and 6am	EL23	
		Parking lots and drives	LPD = 0.1 W/ft ² in LZ-3 & LZ-4 LPD = 0.06 W/ft ² in LZ-2 Controls = auto reduce to 25% (12am to 6am)	EL21	
		Walkways, plaza, and special feature areas	LPD = 0.16 W/ft ² in LZ-3 & LZ-4 LPD = 0.14 W/ft ² in LZ-2 Controls = auto reduce to 25% (12am to 6am)	EL22	
Plug Loads	Equipment Choices	All other exterior lighting	LPD = Comply with Standard 90.1* Controls = auto reduce to 25% (12am to 6am)	EL25	
		Laptop computers	Minimum 2/3 of total computers	PL2,3	
	Controls/Programs	ENERGY STAR equipment	All computers, equipment, and appliances	PL3,5	
		Vending machines	De-lamp and specify best in class efficiency	PL3,5	
		Computer power control	Network control with power saving modes and control off during unoccupied hours	PL2,3	
		Power outlet control	Controllable power outlets with auto OFF during unoccupied hours for classrooms, office, library/media spaces	PL3,4	
Policies	All plug-in equipment not requiring continuous operation to use controllable outlets Implement at least one: • District/school policy on allowed equipment • School energy teams	PL3,4			

*Note: Where the table says "Comply with Standard 90.1," the user must meet the more stringent of either the applicable version of ASHRAE/IES Standard 90.1 or the local code requirements.

Advanced Energy Design Guide

Climate Zone 5 Recommendation Table for K-12 School Buildings (Continued)

	Item	Component	Recommendation	How-to Tips	✓
Kitchen	Kitchen Equipment	Cooking equipment	ENERGY STAR or California rebate-qualified equipment	KE1,2	
		Walk-in refrigeration equipment	6 in. insulation on low-temp walk-in equipment, Insulated floor, LED lighting, floating-head pressure controls, liquid pressure amplifier, subcooled liquid refrigerant, evaporative condenser	KE2,5	
		Exhaust hoods	Side panels, larger overhangs, rear seal at appliances, proximity hoods, VAV demand-based exhaust	KE3,6	
SWH	Service Water Heating	Gas water heater (condensing)	95% efficiency	WH1-5	
		Electric storage EF (≤ 12 kW, ≥ 20 gal)	EF > 0.99 – 0.0012 x Volume	WH1-5	
		Point-of-use heater selection	0.81 EF or 81% E_t	WH1-5	
		Electric heat-pump water heater efficiency	COP 3.0 (interior heat source)	WH1-5	
		Solar hot-water heating	30% solar hot-water fraction when LCC effective	WH7	
		Pipe insulation ($d < 1.5$ in./ $d \geq 1.5$ in.)	1/1.5 in.	WH6	
HVAC	Ground Source Heat-Pump (GSHP) System with DOAS	GSHP cooling efficiency	17.1 EER	HV1,11	
		GSHP heating efficiency	3.6 COP	HV1,11	
		GSHP compressor capacity control	Two stage or variable speed	HV1,11	
		Water-circulation pumps	VFD and NEMA Premium Efficiency	HV8	
		Cooling tower/fluid cooler	VFD on fans	HV1,8,11	
		Boiler efficiency	90% E_c	HV1,7,11	
	Fan-Coil System with DOAS	Maximum fan power	0.4 W/cfm	HV12	
		Exhaust air energy recovery in DOAS	A (humid) zones = 60% enthalpy reduction B (dry) zones = 60% dry-bulb temp reduction C (marine) zones = 60% enthalpy reduction	HV4,5	
		DOAS ventilation control	DCV with VFD	HV4,10,15	
		Water-cooled chiller efficiency	Comply with Standard 90.1*	HV2,6,11	
		Water circulation pumps	VFD and NEMA Premium Efficiency	HV6,7	
		Boiler efficiency	90% E_c	HV2,7,11	
VAV Air-Handling System with DOAS	Maximum fan power	0.4 W/cfm	HV12		
	FCU fans	Multiple speed	HV2,12		
	Economizer	Comply with Standard 90.1*	HV2,14		
	Exhaust air energy recovery in DOAS	A (humid) zones = 60% enthalpy reduction B (dry) zones = 60% dry-bulb temp reduction C (marine) zones = 60% enthalpy reduction	HV4,5		
	DOAS ventilation control	DCV with VFD	HV4,10,15		
	Air-cooled chiller efficiency	10 EER; 12.75 IPLV	HV3,6,11		
Ducts and Dampers	Water-cooled chiller efficiency	Comply with Standard 90.1*	HV3,6,11		
	Water circulation pumps	VFD and NEMA Premium Efficiency	HV6,7		
	Boiler efficiency	90% E_c	HV3,7,11		
	Maximum fan power	0.8 W/cfm	HV12		
	Economizer	Comply with Standard 90.1*	HV3,14		
	Exhaust air energy recovery in DOAS	A (humid) zones = 60% enthalpy reduction B (dry) zones = 60% dry-bulb temp reduction C (marine) zones = 60% enthalpy reduction	HV4,5		
M&V	M&V/ Benchmarking	DOAS ventilation control	DCV with VFD	HV4,10,15	
		Outdoor air damper	Motorized damper	HV10	
		Duct seal class	Seal Class A	HV20	
M&V	M&V/ Benchmarking	Insulation level	R-6	HV19	
		Electrical submeters	Disaggregate submeters for lighting, HVAC, general 120V, renewables, and whole building	QA14-17	
M&V	M&V/ Benchmarking	Benchmarking	Begin submetering early to address issues during warranty period Benchmark monthly energy use Provide training on benchmarking	QA14-17	

*Note: Where the table says "Comply with Standard 90.1," the user must meet the more stringent of either the applicable version of ASHRAE/IES Standard 90.1 or the local code requirements.

Advanced Energy Design Guide

Table 3-1 Primary School Energy Use Targets for 50% Energy Savings

Climate Zone	Plug/Process Loads, kBtu/ft ² ·yr	Lighting, kBtu/ft ² ·yr	HVAC, kBtu/ft ² ·yr	Total, kBtu/ft ² ·yr
1A	11	6	20	37
2A			20	37
2B			20	37
3A			15	32
3B:CA			8	25
3B			14	31
3C			10	27
4A			19	36
4B			15	32
4C			15	32
5A			22	39
5B			17	34
6A			27	44
6B			22	39
7			30	47
8			45	62

Advanced Energy Design Guide

Table 3-2 Secondary School Energy Use Targets for 50% Energy Savings

Climate Zone	Plug/Process Loads, kBtu/ft ² ·yr	Lighting, kBtu/ft ² ·yr	HVAC, kBtu/ft ² ·yr	Total, kBtu/ft ² ·yr
1A	8	7	21	36
2A			21	36
2B			21	36
3A			18	33
3B:CA			10	25
3B			17	32
3C			13	28
4A			22	37
4B			18	33
4C			19	34
5A			25	40
5B			21	36
6A			31	46
6B			26	41
7			34	49
8			48	63

ASHRAE Advanced Energy Design Guide



Advanced Energy Design Guides

Free Download

To promote building energy efficiency, ASHRAE and its partners are making the Advanced Energy Design Guides available for free download (PDF). The zero energy Guides offer designers and contractors the tools needed for achieving zero energy buildings. The 50% Guides offer designers and contractors the tools needed for achieving a 50% energy savings compared to buildings that meet the minimum requirements of Standard 90.1-2004, and the 30% Guides offer a 30% energy savings compared to buildings that meet the minimum energy requirements of Standard 90.1-1999.

ASHRAE, in collaboration with AIA (American Institute of Architects), IES (Illuminating Engineering Society), USGBC (U.S. Green Building Council) and the DOE (Department of Energy) continues to develop the Advanced Energy Design Guide (AEDG) Series.

Free Downloads

ZERO ENERGY

50% ENERGY

30% ENERGY

<https://www.ashrae.org/technical-resources/aedgs>

CBECS HVAC SYSTEMS

Building Mechanical Systems

PNNL-26949



Pacific Northwest
NATIONAL LABORATORY
*Proudly Operated by **Battelle** Since 1965*

Analysis for Building Envelopes and Mechanical Systems Using 2012 CBECS Data

March 2018

DW Winiarski	AL Cooke
MA Halverson	GK Bandyopadhyay
JB Butzbaugh	DB Elliott

U.S. DEPARTMENT OF **ENERGY**

Prepared for the U.S. Department of Energy under Contract DE-AC05-76RL01830

Building Mechanical Systems

- Main heating equipment are:
 - Boilers inside the building
 - District steam or hot water
 - Furnaces that heat air directly
 - Heat pumps for heating
 - Individual space heaters (ISH)
 - Packaged central units (PCUs), roof mounted
 - Some other heating equipment

Building Mechanical Systems

- Main cooling equipment are:
 - Central chillers inside the building
 - District chilled water
 - Heat pumps for cooling
 - Individual room air conditioners (IRAC)
 - Packaged air-conditioning units (PACU)
 - Residential-type central air conditioners (Res CAC)
 - Swamp coolers or evaporative coolers
 - Some other cooling equipment.

Building Mechanical Systems

Table S.4. Most Common HVAC Equipment in Post-1990 Buildings

Number	Type	PNNL Determination ^(a)		
		Heating	Cooling	Air Distribution
1	Large Office	PCU	Chiller	MZ VAV
2	Medium Office	PCU	PACU	MZ VAV
3	Small Office	PCU	PACU	SZ CAV
4	Warehouse	PCU	PACU	SZ CAV
5	Stand-alone Retail	PCU	PACU	SZ CAV
6	Strip Mall	PCU	PACU	SZ CAV
7	Primary School	Boiler	Chiller	SZ CAV
8	Secondary School	Boiler	Chiller	MZ VAV
9	Grocery Store	PCU	PACU	SZ CAV
10	Quick Service Restaurant	PCU	PACU	SZ CAV
11	Full Service Restaurant	PCU	PACU	SZ CAV
12	Hospital	Boiler	Chiller	FCU, CAV and MZ VAV ^(b)
13	Outpatient Health Care	PCU	PACU	MZ VAV ^(c)
14	Small Hotel	ISH	IRAC	SZ CAV
15	Large Hotel	ISH/PCU	IRAC/PACU ^(d)	SZ CAV

(a) PNNL's determinations of the most common building envelope construction and mechanical system prevalence are based on analysis of CBECS data. PNNL utilizes the research and expertise of the authors to make determinations when either CBECS doesn't capture the data, or its data are conflicting or uncertain.

(b) Hospitals may utilize CV systems in some operating and critical care type areas with variable air flow used for pressurization, but classic VAV multi-zone systems in other areas like offices. CBECS guidance seems limited and other sources should be consulted.

(c) Unclear if single zone or multi-zone is more common globally, but where PCU and PACU are used VAV and likely multi-zone is more common.

(d) Large hotels may be best characterized with two system types serving different areas. Both multi-zone systems (VAV or CAV) may serve public spaces (lobby/conference rooms), whereas single zone IRAC or individual room heat pump systems may be most common for room space. Chiller fan coil systems appear more uncommon in new hotels. VAV appears to be found in the majority of large hotel buildings.

(e) System types

PACU – packaged air-conditioning unit	ISH – individual space heater
IRAC – individual room air conditioner	SZ – single zone
MZ – multi-zone	CAV – constant air volume
VAV – variable air volume	FCU – fan coil unit
	PCU – packaged central unit

Building Mechanical Systems

Table 3.1. HVAC Equipment in Post-1990 Buildings in 2012 CBECS

Prototype Number	Prototype Building	By Number of Buildings		By Floor Area	
		Heating	Cooling	Heating	Cooling
1	Large Office	PCU 67% Boilers 17% HP 10%	PACU 61% Chillers 27% HP 10%	PCU 48% Boilers 24% District 15%	Chillers 52% PACU 30% District 10%
2	Medium Office	PCU 50% Furnace 22% Boilers 9%	PACU 42% Res CAC 31% HP 18%	PCU 54% Boilers 18% Furnace 11%	PACU 56% HP 18% Res CAC 13%
3	Small Office	PCU 56% Furnace 22% HP 16%	Res CAC 43% PACU 33% HP 18%	PCU 67% Furnace 16% HP 12%	PACU 46% Res CAC 32% HP 16%
4	Warehouse	None 55% PCU 26% ISH 9%	None 57% PACU 16% Res CAC 16%	PCU 51% None 24% ISH 9%	PACU 49% None 23% Res CAC 13%
5	Stand-alone Retail	PCU 63% HP 15% Furnace 11%	PACU 49% Res CAC 25% HP 17%	PCU 81% HP 6% None 6%	PACU 73% Res CAC 10% HP 7%
6	Strip Mall	PCU 76% Furnace 11% HP 6%	PACU 63% Res CAC 18% Heat Pumps 16%	PCU 85% Furnace 4% Other 4%	PACU 80% Res CAC 9% Heat Pumps 9%
7	Primary School	PCU 59% HP 14% Boilers 14% Furnace 7% None 3%	PACU 48% HP 15% Res CAC 14% Chillers 11% District 8%	Boilers 45% PCU 37% HP 13% ISH 2% Furnace 2%	Chillers 39% PACU 31% HP 15% Res CAC 6% District 4%
8	Secondary School	PCU 55% Boilers 15% District 11% HP 10% ISH 4%	PACU, 34% Res CAC, 22% Chillers, 15% District, 14% HP, 9%	Boilers 41% District 26% PCU 20% HP 10% Furnace 1%	Chillers, 39% District, 30% PACU, 16% HP, 10% Res CAC, 4%
9	Grocery Store	PCU 66% None 20% ISH 7%	PACU 53% Res CAC 21% IRAC 10%	PCU 87% Boilers 6% Furnace 4%	PACU 78% Res CAC 16% None 5%
10	Quick Service Restaurant	PCU 72% None 11% HP 7%	PACU 65% Res CAC 12% None 9%	PCU 78% None 9% HP 7%	PACU 67% Res CAC 15% None 8%
11	Full Service Restaurant	PCU 62% HP 11% Furnace 10%	PACU 40% Res CAC 33% HP 14%	PCU 69% HP 7% Furnace 7%	PACU 42% Res CAC 24% HP 13%
12	Hospital	Boilers 67% PCU 14% District 14%	Chillers 76% PACU 17% District 7%	Boilers 76% District 17% PCU 6%	Chillers 79% District 12% PACU 9%
13	Out Patient Health Care	PCU 67% Furnace 13% Boilers 10%	Res CAC 44% PACU 32% HP 13%	PCU 57% Boilers 29% Furnace 6%	PACU 45% Chillers 31% Res CAC 17%
14	Small Hotel	ISH 40% Boilers 24% PCU 17%	IRAC 73% Res CAC 17% None 6%	Boilers 40% ISH 36% PCU 17%	IRAC 74% Res CAC 17% HP 5%
15	Large Hotel	ISH 39% HP 34% PCU 21%	IRAC 45% PACU 30% HP 20%	ISH 27% PCU 26% HP 21%	IRAC 37% PACU 22% Chillers 16%

DISTRICT HEATING AND COOLING

District Heating & Cooling

- What does district heating and cooling systems mean?

District Heating & Cooling

- District Heating:
 - Heat generated in a centralized location
 - Delivered through insulated systems
 - Used for space heating and water heating
- What are the pros and cons?
- Is there an example of district heating and cooling system?

District Heating & Cooling

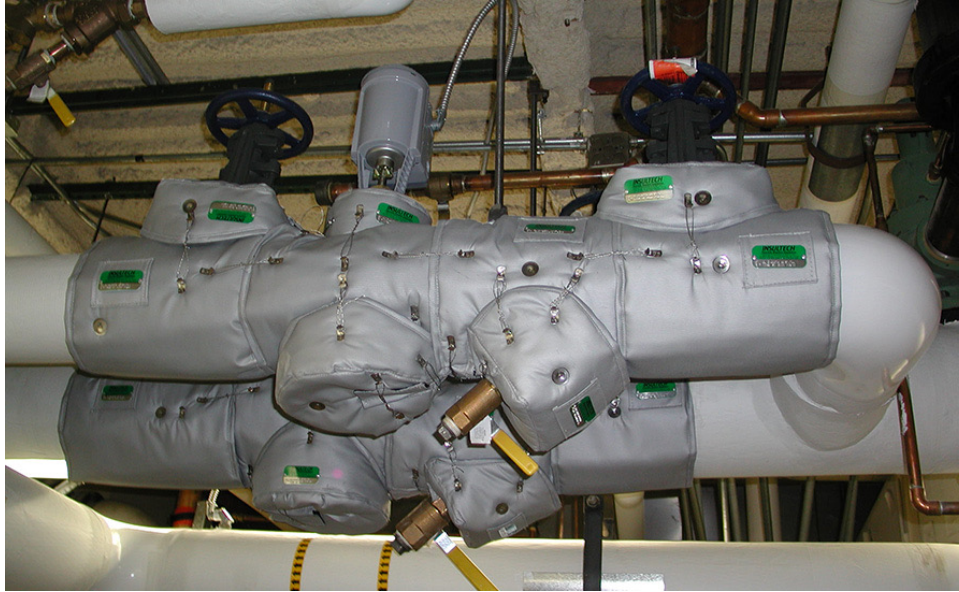

<https://www.snipsmag.com/articles/93220-new-york-medical-center-saves-energy-with-insulation>



<https://www.ilworldtour.com/the-%E2%80%9Csteamy%E2%80%9D-underbelly-of-new-york-city/>

District Heating & Cooling

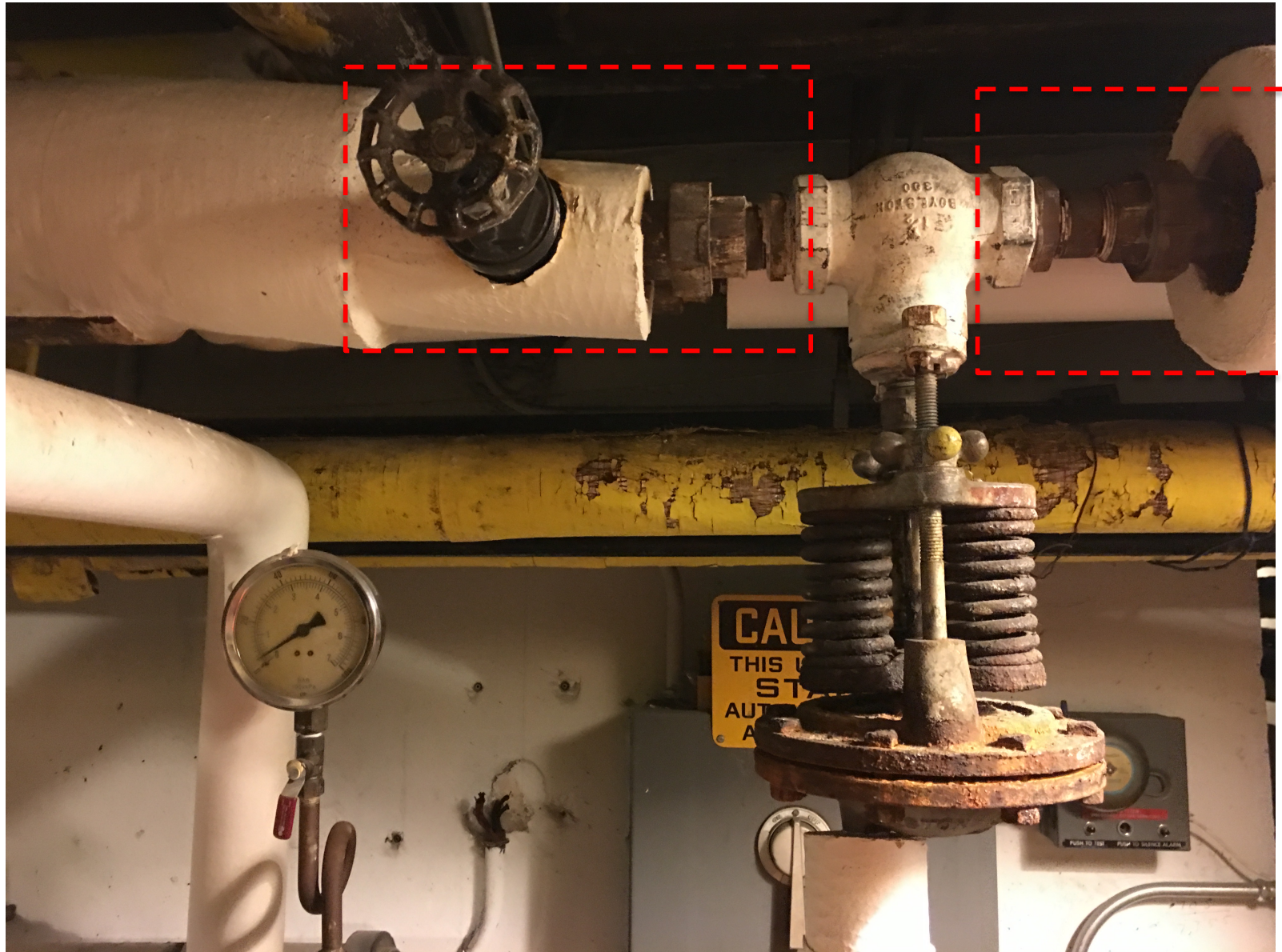

District Heating & Cooling

- Energy efficiency measure for steam reduction
 - Steam and condensate pipe insulation
 - Uninsulated steam pipe can have surface temperatures up to 350 degrees F.
 - Insulated over 7,800 linear feet of pipe in 28 buildings on campus
 - Steam traps
 - Steam traps are used to remove condensate from steam system. Many steam traps fail open, wasting steam.
 - Replaced 185 failed steam traps on campus
 - Annual energy savings of:
 - 20 million KBTU

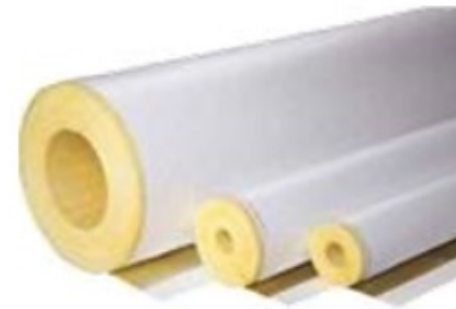

District Heating & Cooling

- Examples of insulating the system

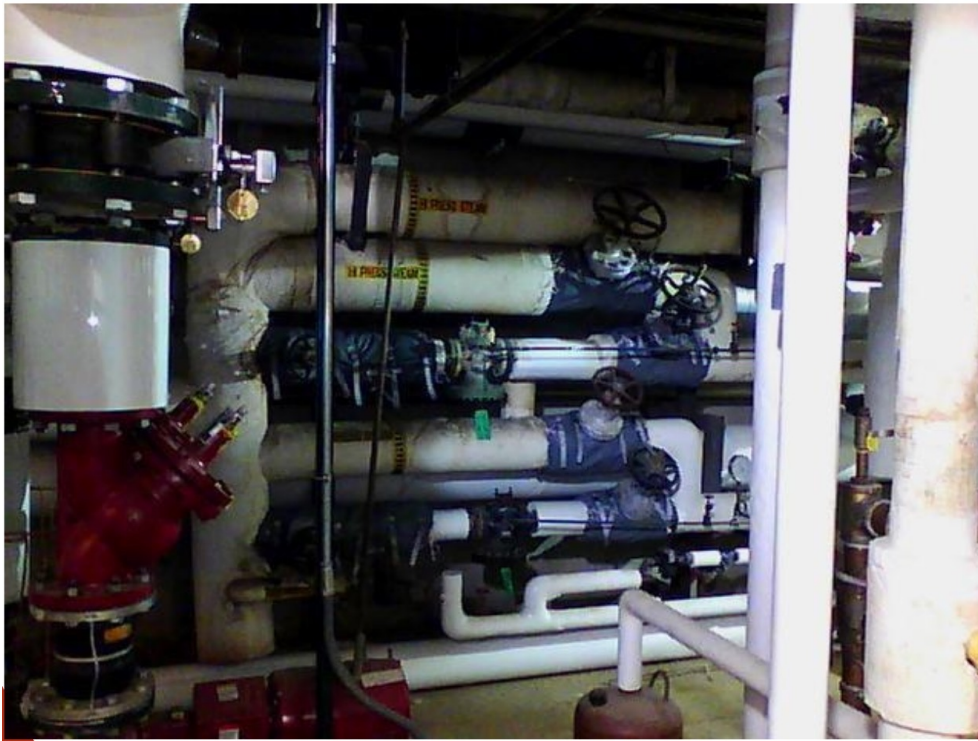

District Heating & Cooling

- Cooling plant

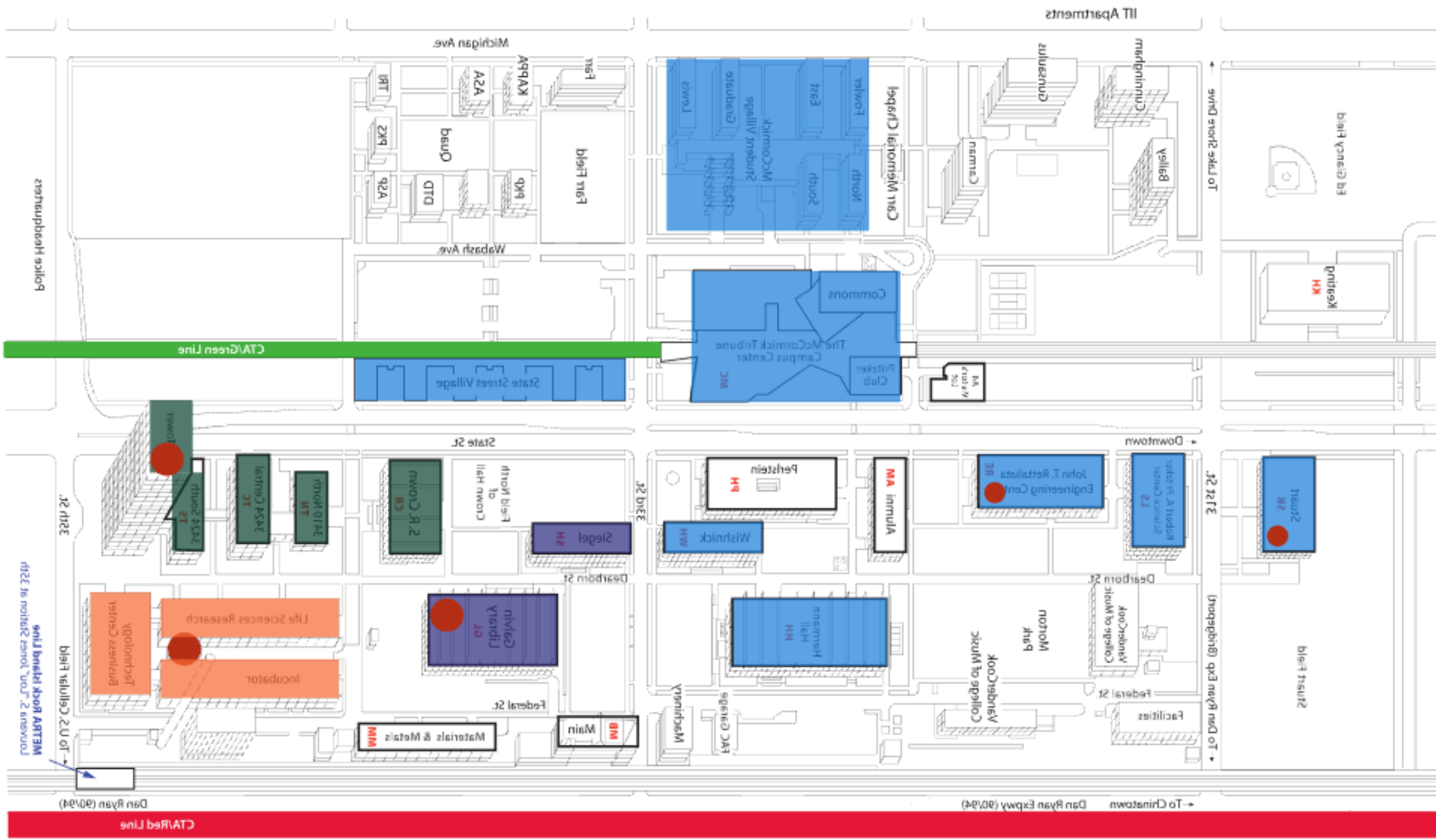

District Heating & Cooling

- District heating and cooling:
 - ❑ No assumption required on:
 - ❑ Steam
 - ❑ Chilled water generation

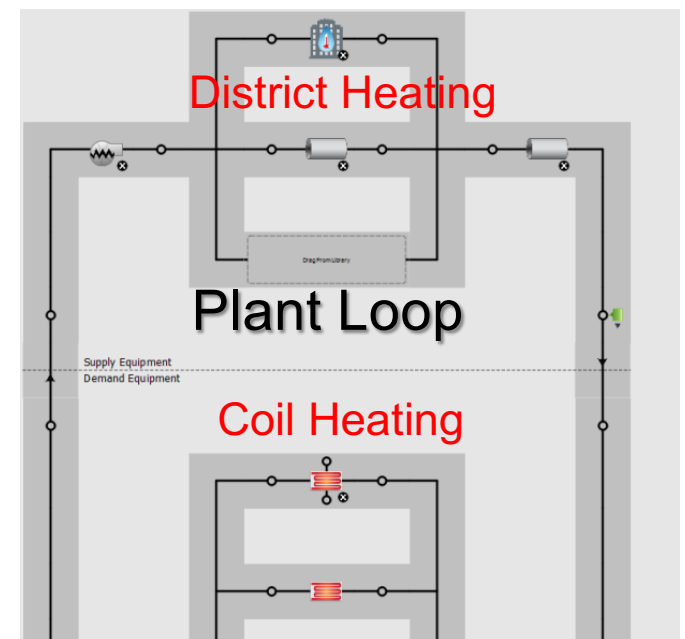
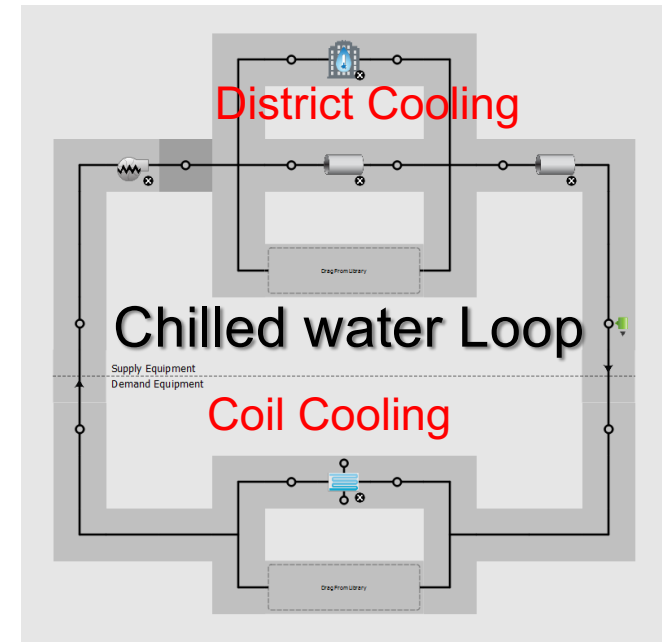
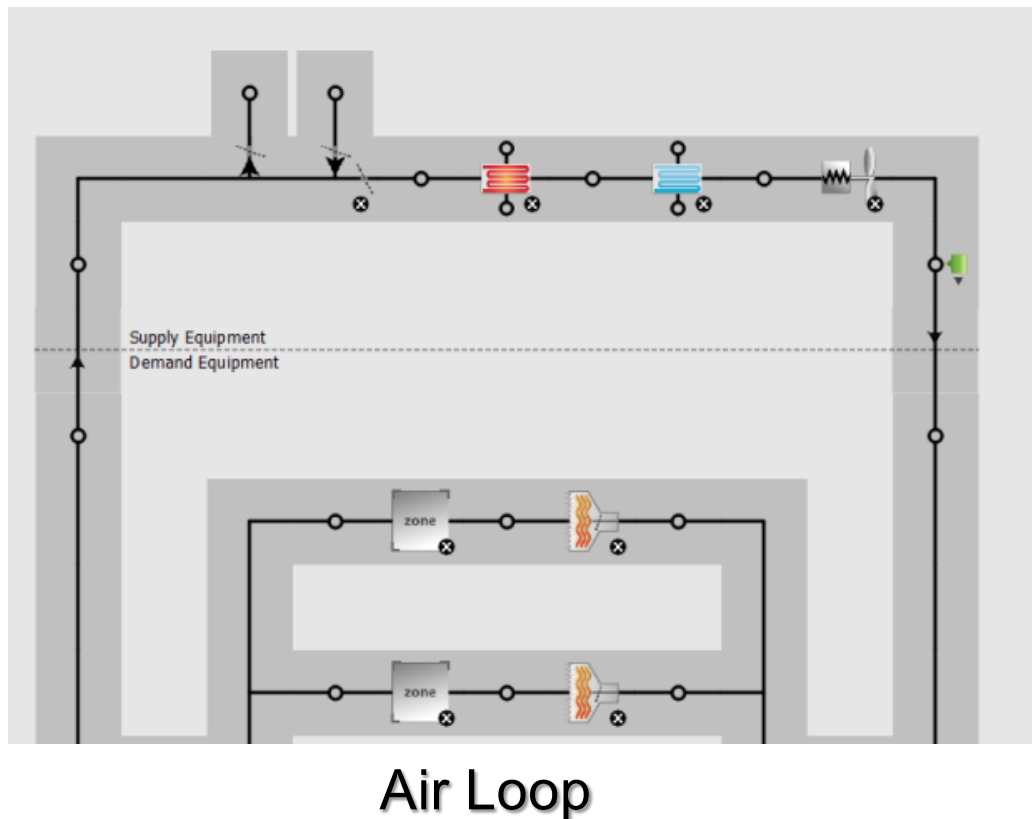

BCL

BCL

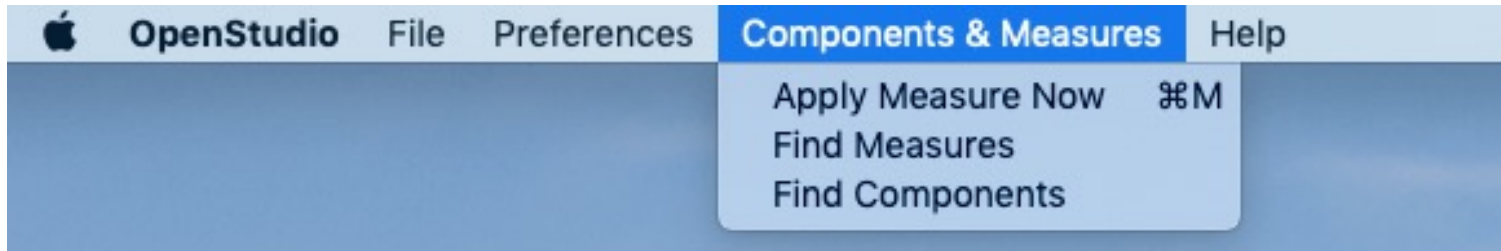

Online BCL

Categories

- Construction Assembly
- Material
- HVAC

Check All

Construction Assembly	3913
Name: 189.1-2009 Nonres 1A Attic Floor Type: OS:Construction	<input type="checkbox"/>
Name: 189.1-2009 Nonres 1A Door Non-Swinging Type: OS:Construction	<input type="checkbox"/>
Name: 189.1-2009 Nonres 1A Door Swinging Type: OS:Construction	<input type="checkbox"/>
Name: 189.1-2009 Nonres 1A Exposed Floor Mass Type: OS:Construction	<input type="checkbox"/>
Name: 189.1-2009 Nonres 1A Ext Slab Unheated- 4in Slab without Carpet Type: OS:Construction	<input type="checkbox"/>
Name: 189.1-2009 Nonres 1A Ext Slab Unheated- 4in Slab with Carpet Type: OS:Construction	<input type="checkbox"/>
Name: 189.1-2009 Nonres 1A Ext Slab Unheated- 8in Slab without Carpet Type: OS:Construction	<input type="checkbox"/>
Name: 189.1-2009 Nonres 1A Ext Slab Unheated- 8in Slab with Carpet Type: OS:Construction	<input type="checkbox"/>
Name: 189.1-2009 Nonres 1A Ext Wall Mass Type: OS:Construction	<input type="checkbox"/>
Name: 189.1-2009 Nonres 1A Ext Wall Metal Building	<input type="checkbox"/>

Attributes

Effective R-value	6.50...
Film Coefficients	false
Insulation Minimum R-value (ft*2 F h/Btu)	R-38
Construction Type	Attic...
Construction	Attic...
Climate Zone	ASH...
OpenStudio Type	OS:C...
Standard	ASH...
Standard Type	Nonr...

Arguments

Files

189.1-2009 Nonres 1A Attic Floor_v7.1.0.idf
189.1-2009 Nonres 1A Attic Floor_v0.9.3.osm
189.1-2009 Nonres 1A Attic Floor_v0.9.3.osc

Sources

Tags

Construction Assembly.Floor.Attic Floor

SERVICE HOT WATER

Service Hot Water

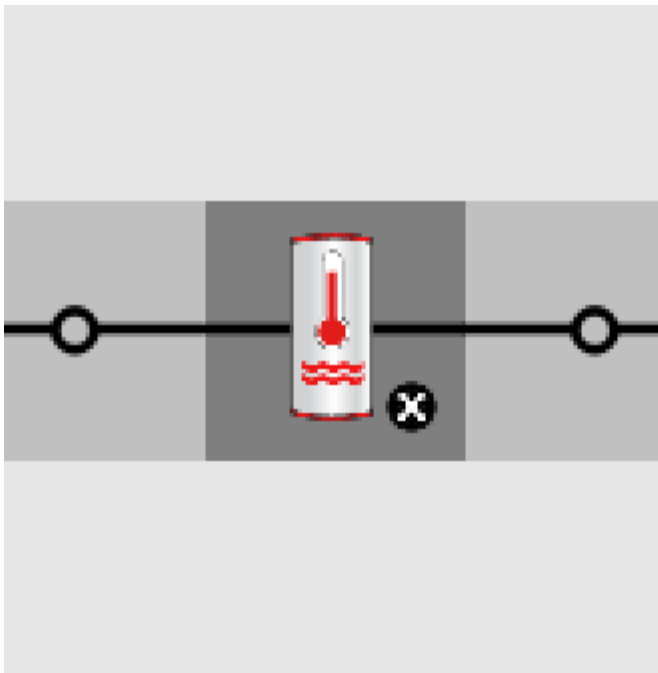

Service Hot Water

- Add a water heater tank to a plant loop:

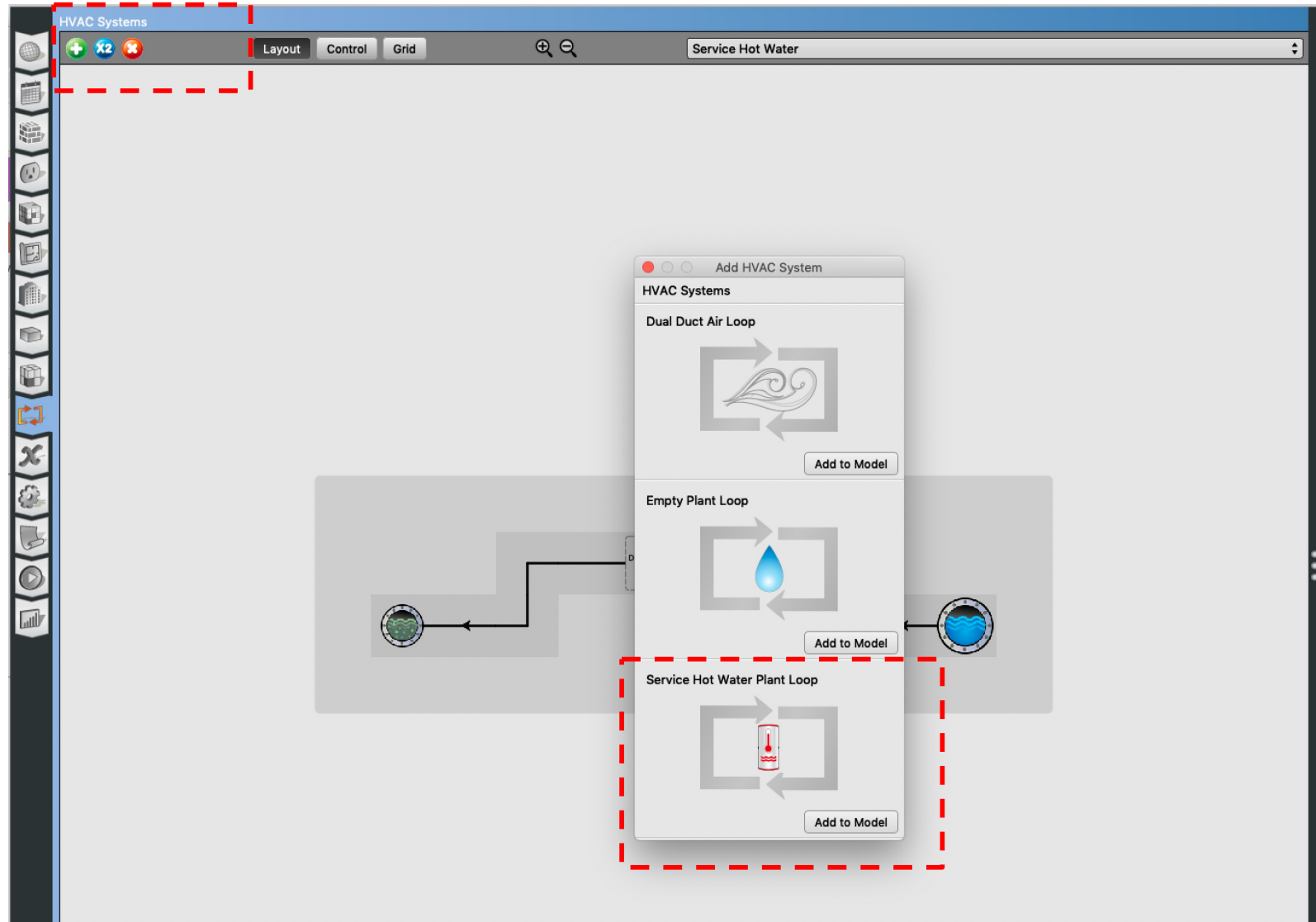

Service Hot Water

- Add service hot water plant loop:

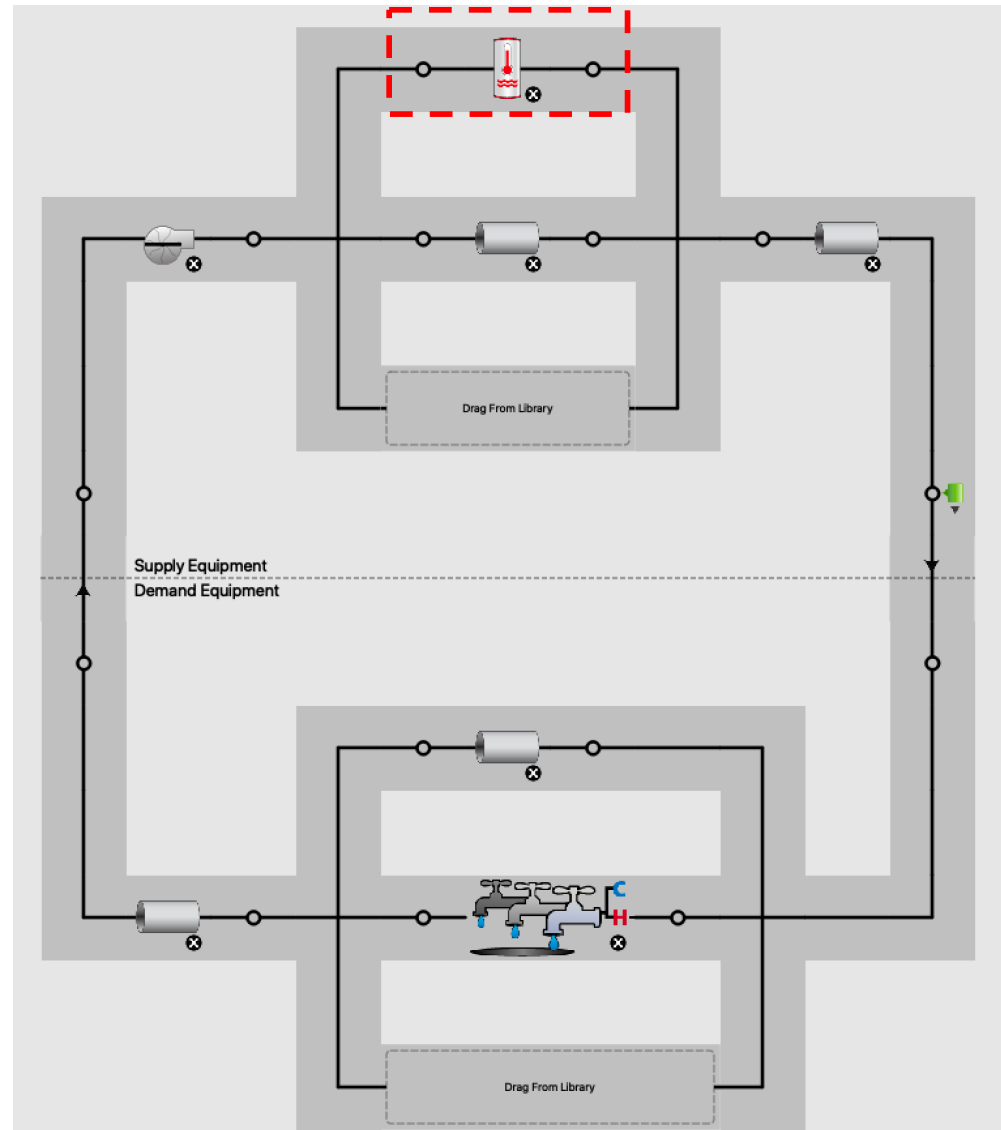

Service Hot Water

- Add a fixture:

HVAC Systems

Water Use Connection

Service Hot Water

Drag Water Use Equipment from Library

Loop

Loop

Loop

Loop

Availability Manager Hybrid Ventilation

Availability Manager Night Ventilation

Availability Manager Night Cycle

Availability Manager Optimum Start

Availability Manager Differential Thermostat

Availability Manager High Temperature Turn Off

Availability Manager High Temperature Turn On

Availability Manager Low Temperature Turn Off

Availability Manager Low Temperature Turn On

Availability Manager Scheduled Off

Availability Manager Scheduled On

Availability Manager Scheduled

AirLoopHVAC Unitary VAV Changeover Bypass

AirLoopHVAC Unitary System

Service Hot Water

The image displays two screenshots of a software interface for designing HVAC systems, specifically focusing on Service Hot Water (SHW) systems. The top screenshot shows a basic loop configuration with a central equipment unit and two loops. The bottom screenshot shows a more detailed connection diagram with a central equipment unit and two loops, with a red dashed arrow pointing from the top diagram to the bottom one.

Top Screenshot:

- Window Title: Test.osm*
- Menu: File, Preferences, Components & Measures, Help
- Panel: HVAC Systems
- Text: SHW WUC 0.0gpm at 140F
- Diagram: Service Hot Water loop with a central equipment unit labeled "Drag Water Use Equipment from Library". Two loops are shown, each with a "Loop" label and a circular icon.

Bottom Screenshot:

- Window Title: Test.osm*
- Menu: File, Preferences, Components & Measures, Help
- Panel: HVAC Systems
- Text: Service Hot Water
- Diagram: Service Hot Water loop with a central equipment unit labeled "Drag Water Use Connections from Library". Two loops are shown, each with a circular icon.

A red dashed arrow points from the top diagram to the bottom diagram, indicating a transition or comparison between the two stages of the design process.

Service Hot Water

- Add service hot water definition

The screenshot shows a software interface for defining service hot water loads. The main window is titled "Loads" and has a sidebar on the left with various definition categories. The "Water Use Equipment Definitions" category is expanded, showing a list of definitions. The "Water Fixture Definition" is selected and highlighted with a red dashed box. The main area displays the configuration for this definition:

- Name:** Water Fixture Definition
- End Use Subcategory:** General
- Peak Flow Rate:** 1.000155 gal/min
- Target Temperature Schedule:** Drag From Library
- Sensible Fraction Schedule:** Drag From Library
- Latent Fraction Schedule:** Drag From Library

The right sidebar contains a list of construction and schedule categories, including Ruleset Schedules, Compact Schedules, Constant Schedules, Year Schedules, Fixed Interval Schedules, Variable Interval Schedules, Constructions, Internal Source Constructions, C-factor Underground Wall Constructions, F-factor Ground Floor Constructions, and Window Data File Constructions.

Service Hot Water

- DOE Reference Buildings
 - Section 5.1.6 Service Water Heater Demand

Table 11 Peak Service Hot Water Demand and Data Sources

Space Type	Use Rate		Temp. at Fixture		Data Sources
	gal/h	L/h	°F	°C	
Guest room (small hotel)	1.75	6.6	110	43	Jiang et al. 2008, ASHRAE 2007
Guest room (large hotel)	1.25	4.7	110	43	Jiang et al. 2008, ASHRAE 2007
Laundry (small hotel)	67.5	255.5	140	60	Jiang et al. 2008, ASHRAE 2007
Laundry (large hotel)	156.6	592.8	140	60	Jiang et al. 2008, ASHRAE 2007
Restrooms (primary school)	56.5	214.0	110	43	ASHRAE 2007
Restrooms (secondary school)	104.4	395.0	110	43	ASHRAE 2007
Gym (secondary school)	189.5	717.2	110	43	ASHRAE 2007
Small office	3.0	11.4	110	43	Jarnagin et al. 2006, ASHRAE 2007
Medium office (per floor)	9.9	37.5	110	43	Jarnagin et al. 2006, ASHRAE 2007
Large office (per floor)	21.3	80.6	110	43	Jarnagin et al. 2006, ASHRAE 2007
Apartment	3.5	13.2	110	43	Gowri et al. 2007
Outpatient healthcare	30.0	113.5	110	43	Doebber et al. 2009
Hospital					
ER waiting room	1.0	3.8	120	49	Engineering judgment
Operating/surgical cystoscopic	2.0	7.6	120	49	Engineering judgment
Laboratory	2.0	7.6	120	49	Engineering judgment
Patient room	1.0	3.8	120	49	Engineering judgment

Service Hot Water

- Make reasonable assumptions for the water heater temperature:
 - Most households require about 120 °F
 - Some manufacturers set water heater thermostats at 140 °F, which also slows mineral buildup and corrosion in your water heater and pipes
 - Water heated at 140°F also poses a safety hazard (scalding)

Service Hot Water

- Make reasonable assumptions for the flow rates and sizes. For example for residential units:
 - Small size: A 50 to 60-gallon storage tank is usually sufficient for 1 to 3 people
 - Medium size: A 80-gallon storage tank works well for 3 to 4 people
 - Large size: A large tank is appropriate for four to six people

Service Hot Water

- You can use the OpenStudio measures:

The screenshot shows the OpenStudio Online BCL interface. The left sidebar displays a tree view of categories, with 'Service Water Heating' expanded and 'Water Heating' selected. The main panel shows a list of measures under the heading 'Service Water Heating'. The measures are:

Name	Measure Type	Checked
Set Water Heater Efficiency, Heat Loss, and Peak Water Flow Rate	ModelMeasure	<input type="checkbox"/>
Set Site Water Mains Temperature	ModelMeasure	<input type="checkbox"/>
AedgK12SwH	ModelMeasure	<input checked="" type="checkbox"/>
AedgOfficeSwH	ModelMeasure	<input checked="" type="checkbox"/>
ZEDG K12 SWH	ModelMeasure	<input checked="" type="checkbox"/>
Add SWH Loop	ModelMeasure	<input checked="" type="checkbox"/>
Water Heater Mixed Multiplier	ModelMeasure	<input type="checkbox"/>
Water Heater Mixed Percent Change	ModelMeasure	<input type="checkbox"/>

Service Hot Water

- You can use the OpenStudio measures:

- First, use “Add SHW Loop”

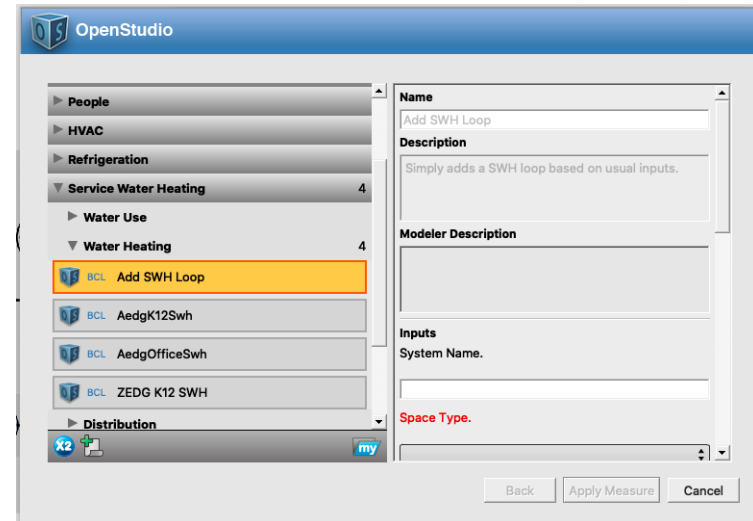

- Second, use “ZEDG K12 SHW”

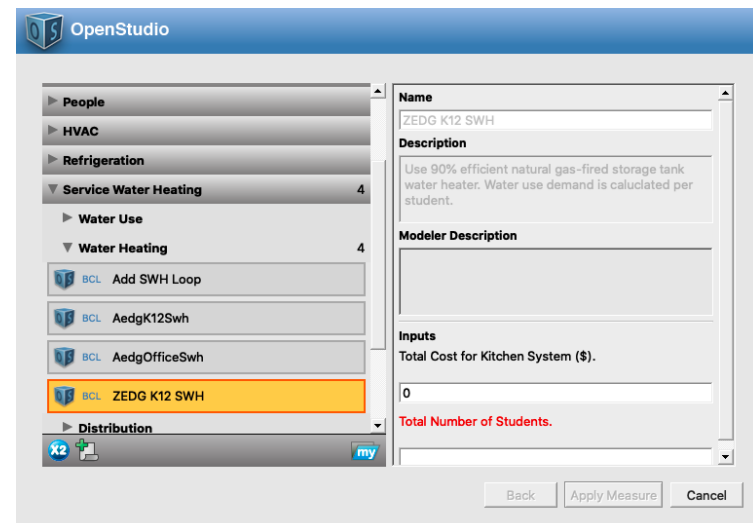

GROUND SOURCE HEAT PUMP (EXTRA)

Ground Source Heat Pump

- Ground Source Heat Pump (GHP) benefits from:
 - ❑ Relative constant ground temperature (about 30 ft)
 - 50 °F (10 °C) to 59 °F (15 °C)
 - Soil temperature warmer than air in winter and colder than the air temperature in summer
 - ❑ Thermal storage capacity of the ground
 - Sink in summer time
 - Source in winter time

Ground Source Heat Pump

- Undisturbed ground temperature in the U.S.:

ORNL 2001-03084/abl

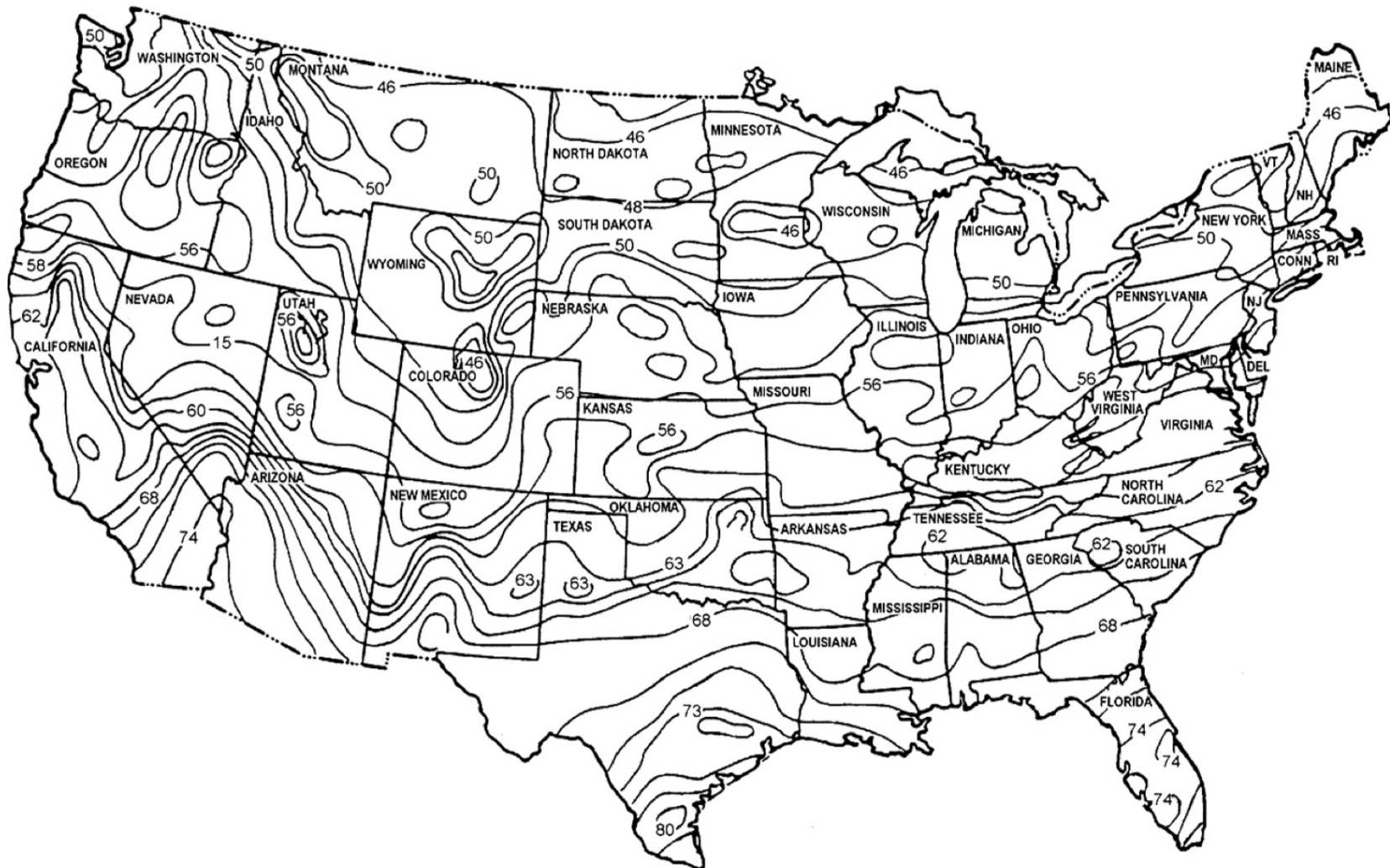

Ground Source Heat Pump

- Key components are:
 - ❑ A heat exchanger
 - A group of pipes buried in the ground
 - Immersed in a surface water body
 - Exchanging heat directly with ground water
 - ❑ Distribution systems
 - Ductwork for forced air heating/cooling and/or,
 - In-floor piping for radiant heating
 - ❑ Heat Pump (HP)
 - Connect the distribution system with the ground heat exchangers

Ground Source Heat Pump

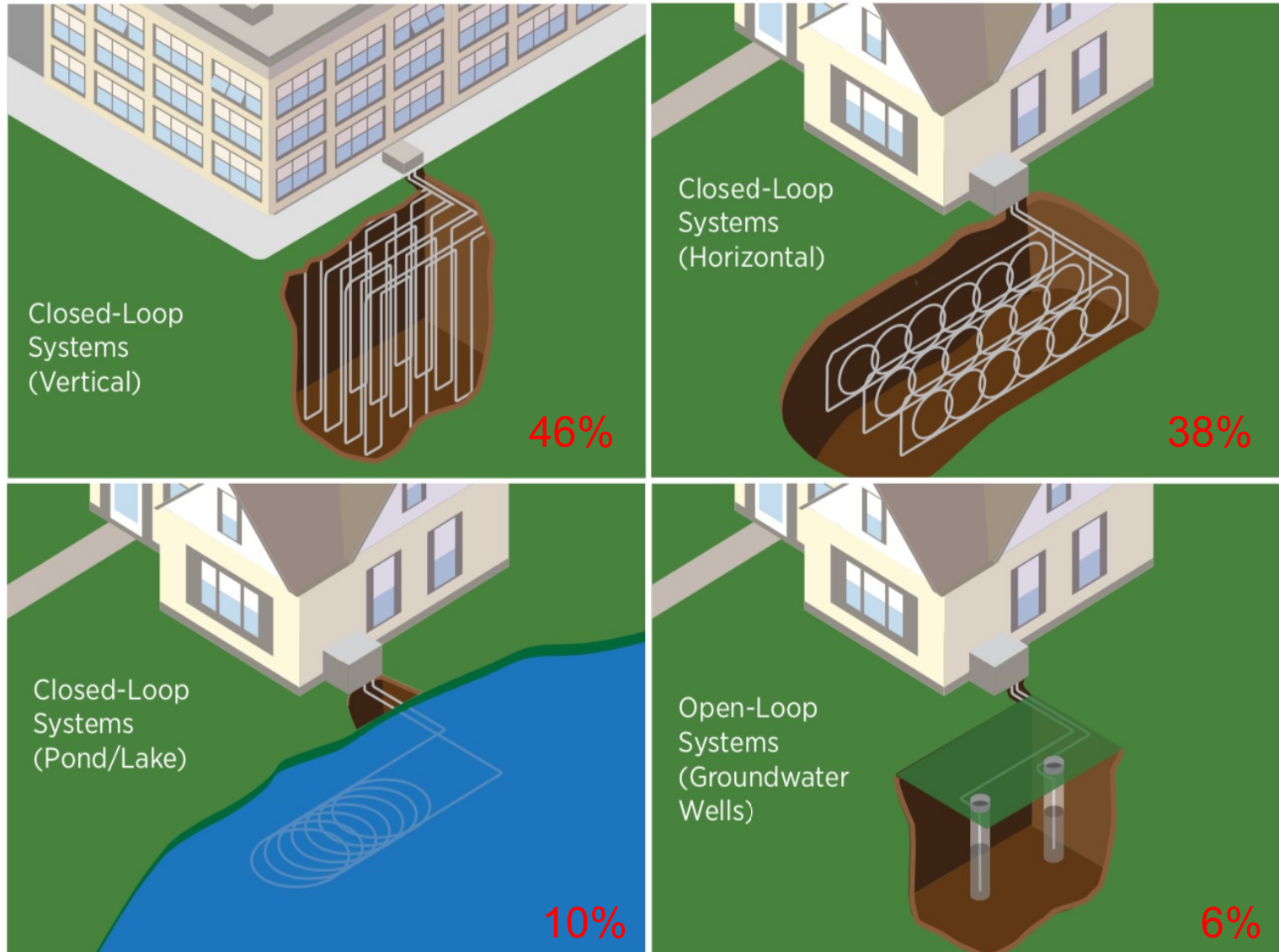

What are the benefits and setbacks of each system? Which is one that is more common in the US?

Ground Source Heat Pump



<https://www.oldhouseonline.com/repairs-and-how-to/geothermal-options-old-homes>

<https://www.homebuilding.co.uk/ground-source-heat-pumps-need-know/>

GeoVision Report 2019

Ground Source Heat Pump

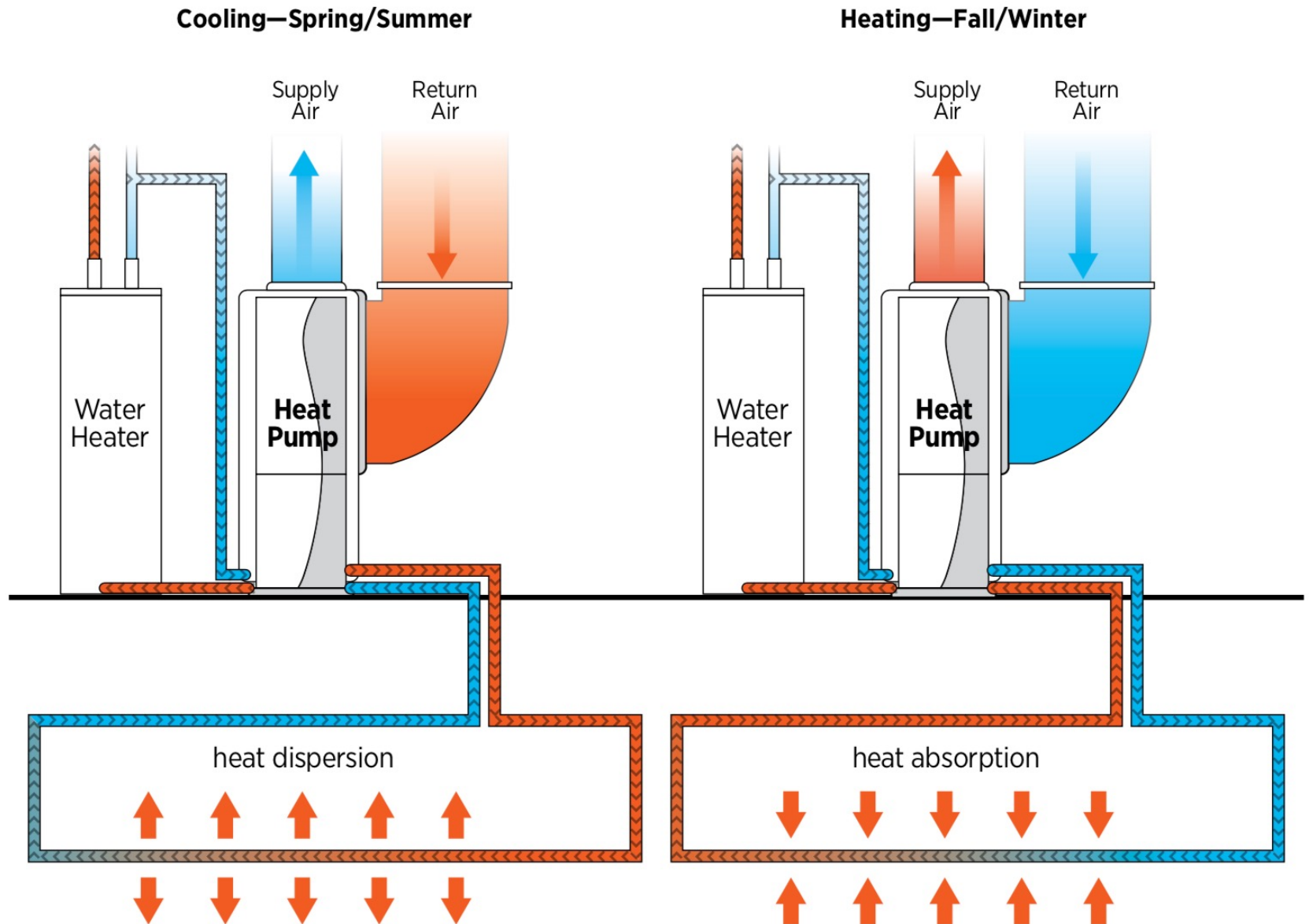

Ground Source Heat Pump

- Installed capacity in the U.S. was 16,800 MW (or 4.8 million cooling tons) as of 2016
- GHP is being used more in residential buildings than commercial buildings
- In residential buildings:
 - ❑ 75% in new construction
 - ❑ 25% in retrofitted homes
- GHPs account for 1% of the U.S. HVAC market

Ground Source Heat Pump

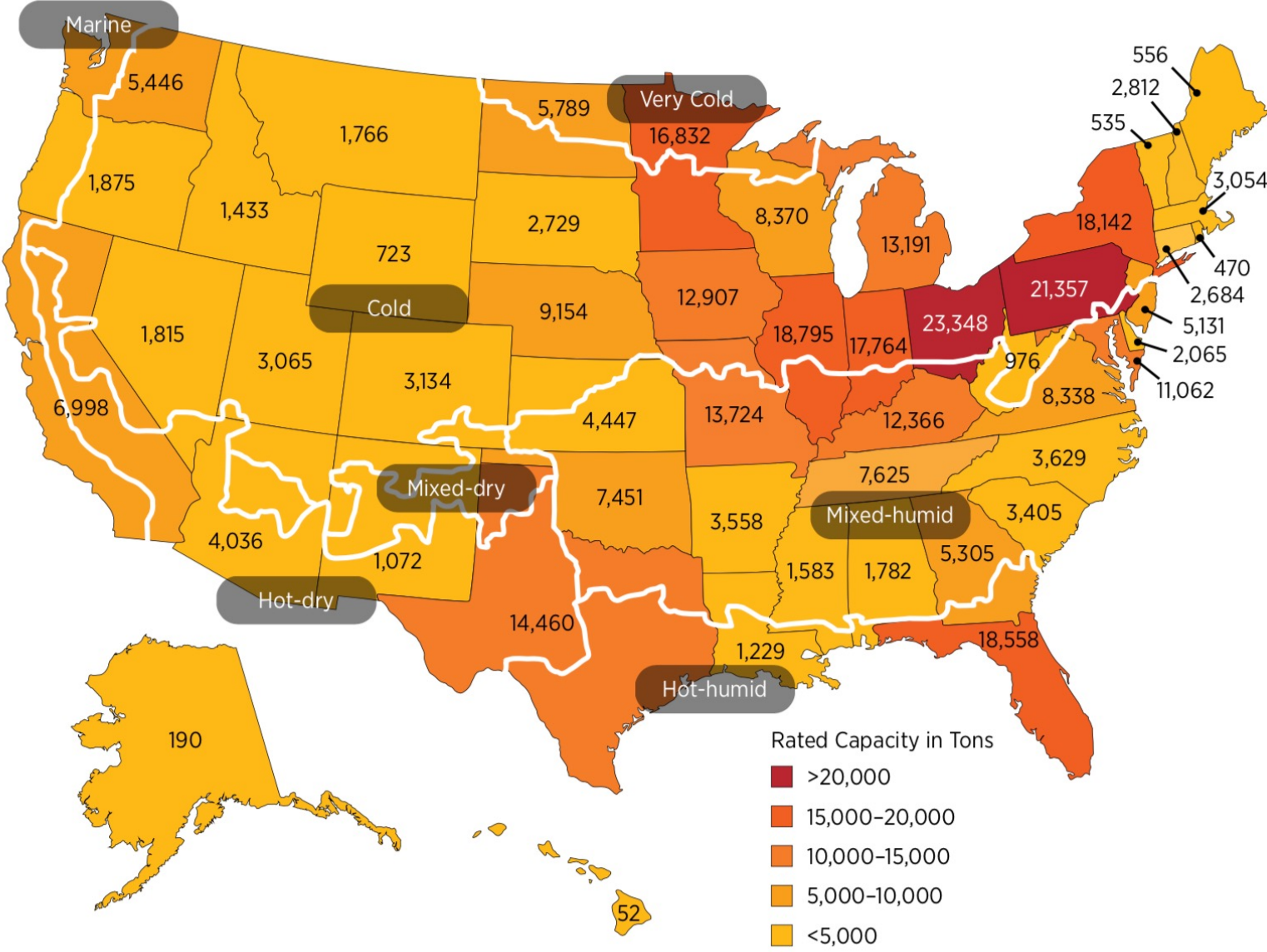

Ground Source Heat Pump

- 10 states account for 52% of the GHP shipments:
 - ❑ Florida, Illinois, Indiana, Michigan, Minnesota, Missouri, New York, Ohio, Pennsylvania, and Texas
 - ❑ Concentrated in areas with cold climate and high population density

Ground Source Heat Pump

- The most common GHP system configuration in the US homes are:
 - ❑ A packaged heat pump
 - ❑ Split water-to-air heat pump (WAHP) with a centrally ducted forced-air distribution system that conditions:
 - One floor of a multistory home
 - The entire house

Ground Source Heat Pump

- For commercial buildings distributed GHP systems are the most common:
 - ❑ Each zone of the building is conditioned with an individual WAHP
 - ❑ Multiple WAHPs are connected to a common water loop
 - ❑ Use a two-pipe water loop with a variable speed central pumping
 - ❑ The cooling capacities of the WAHP units usually range from 0.5 to 20 ton (1.74–70 kW)

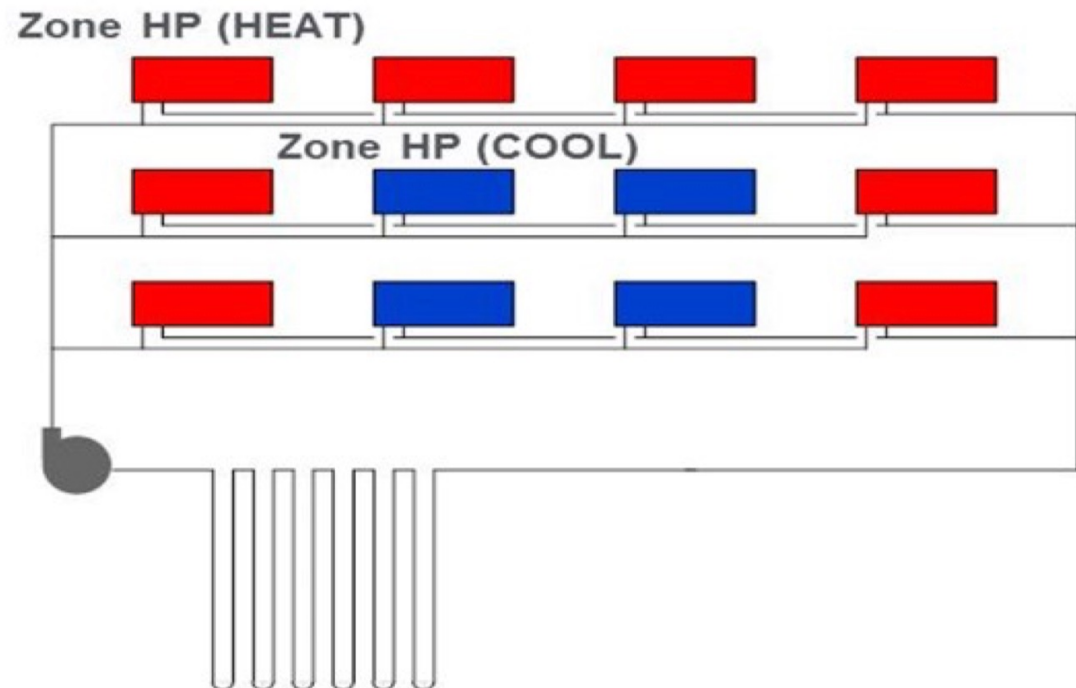

Ground Source Heat Pump

- Central GHP systems use large heat pumps or modular water-to-water heat pumps to:
 - ❑ Generate hot and/or chilled water for delivery to the conditioned space (a good option for retrofitting existing central chiller and boiler systems)
 - ❑ To satisfy the simultaneous demands for heating and cooling in different zones of a building (what's the pipe configuration?)

Ground Source Heat Pump

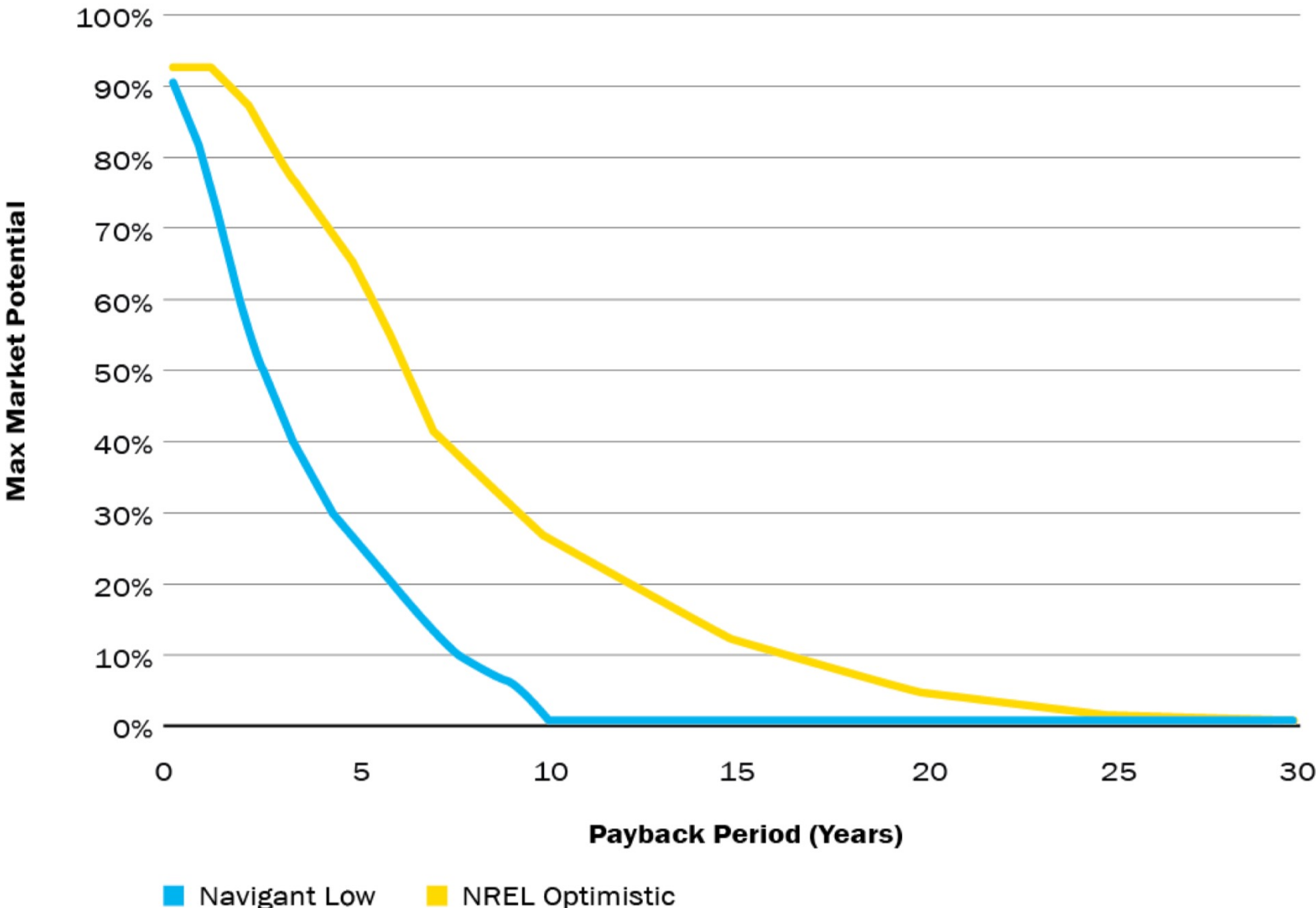

Ground Source Heat Pump

- Cost depends on the geological conditions, building loads, system designs, and the HP equipment. For a typical:
 - ❑ Home varies from \$3,000 to \$5,000
 - ❑ Large-scale housing retrofit is about \$4,600 per ton (in 2006)
 - ❑ For commercial buildings, the cost ranges are (in 2012):

Item	Cost (\$)
Water-source heat pump	2.5–4/ft ²
Closed-loop vertical GHX	6.76–15/ft
Total system	13–26/ft ²

- A simple payback is about 8-14 years for a retrofit project and shorter for a new construction.

Ground Source Heat Pump (AEDG K-12)

- GSHP (AEDG K-12):
 - ❑ One DOAS air loop
 - ❑ One HP loop (similar to a plant loop)
 - ❑ Zone level equipment

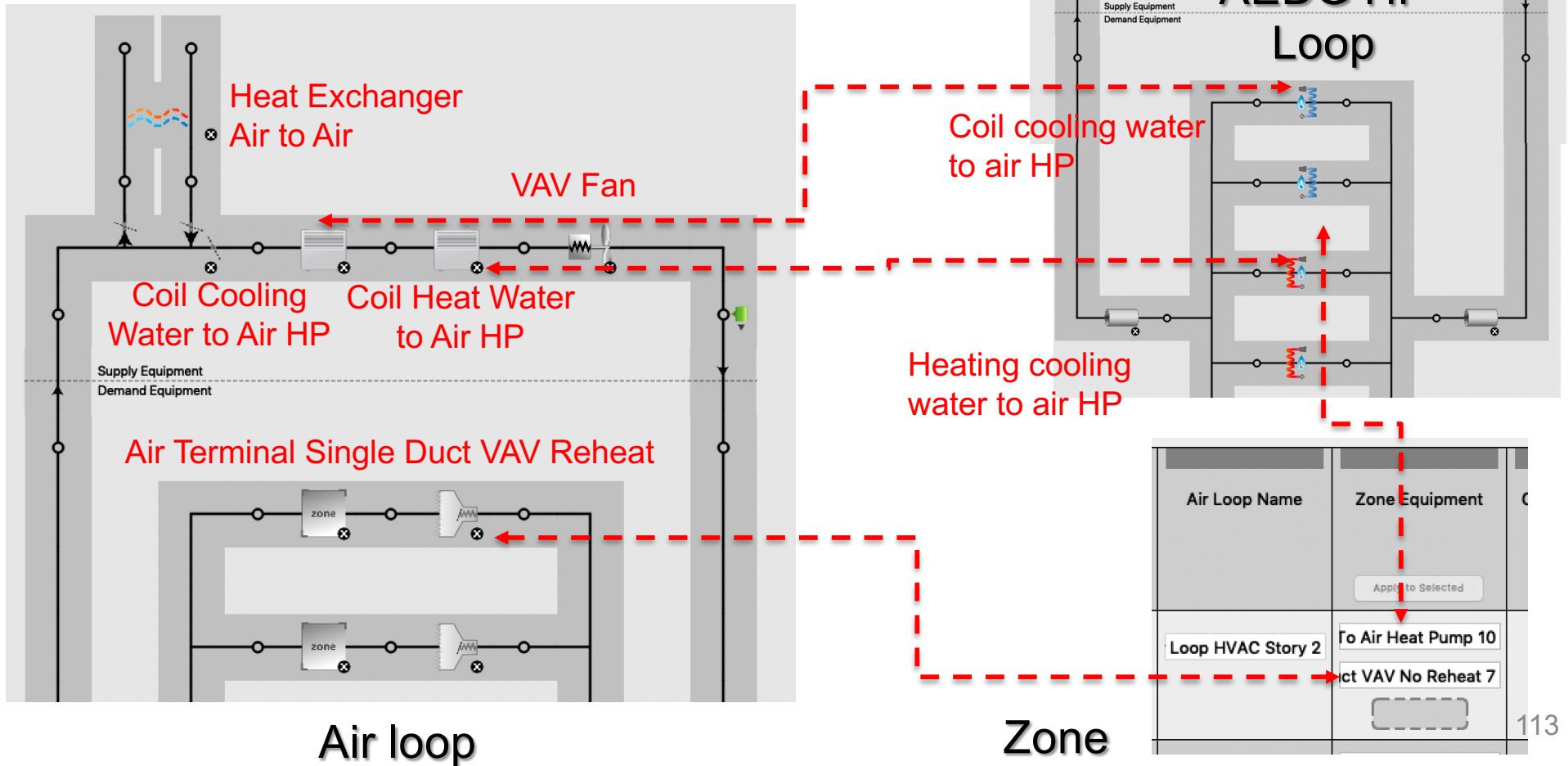

PASSIVE CHILLED BEAMS (EXTRA)

Passive Chilled Beams

- There are two types of chilled beams
 - ❑ Active (air comes from the AHU and is pressurized)
 - ❑ Passive (no moving part)



Passive Chilled Beams

- It works based on the natural convection
 - ❑ Water temperature is about 57 F (15-20 F colder than the air temperature)

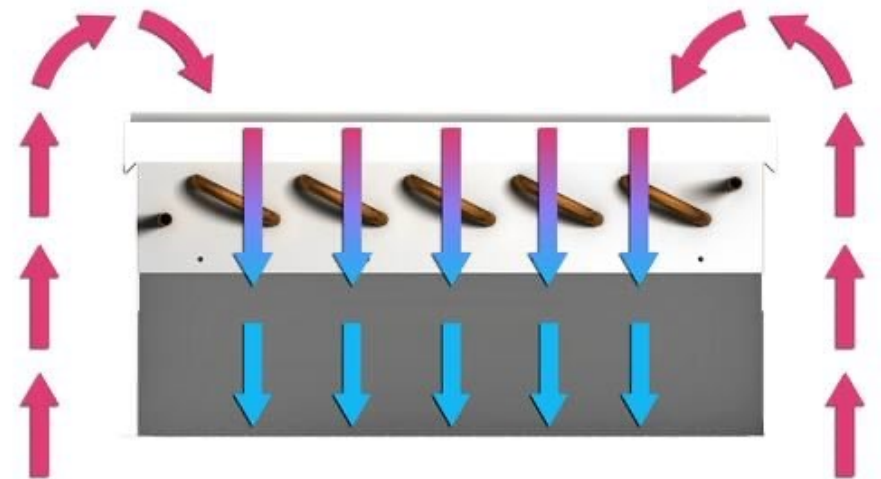

Passive Chilled Beams

- Since moving parts are involved, it is energy efficient
- It is usually used with other air systems such as
 - Displacement ventilation
 - Under floor
 - Active chilled beams

CHILLED CHILLED BEAMS (EXTRA)

Active Chilled Beams

- Relatively energy efficient over time, reduce the size of the ductwork, and lower the noise level



Active Chilled Beams

- From AHU to plenum – and then pressurized and move to the space

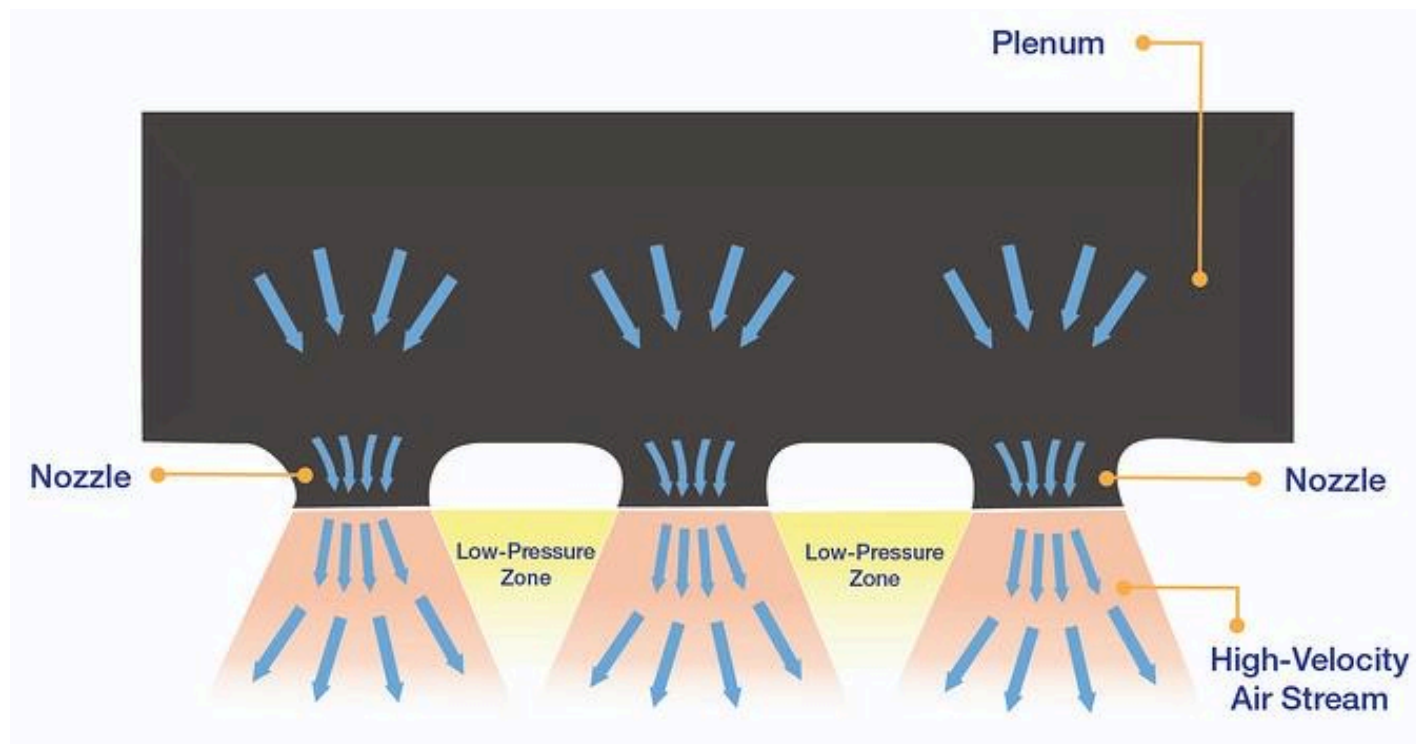

Active Chilled Beams

- The ratio of air through nozzles versus the induced is important

